

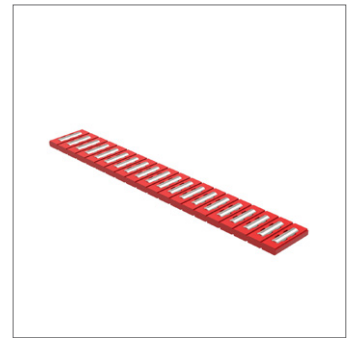

# Linear Cage - Needle Roller

## Ball & Needle Cages

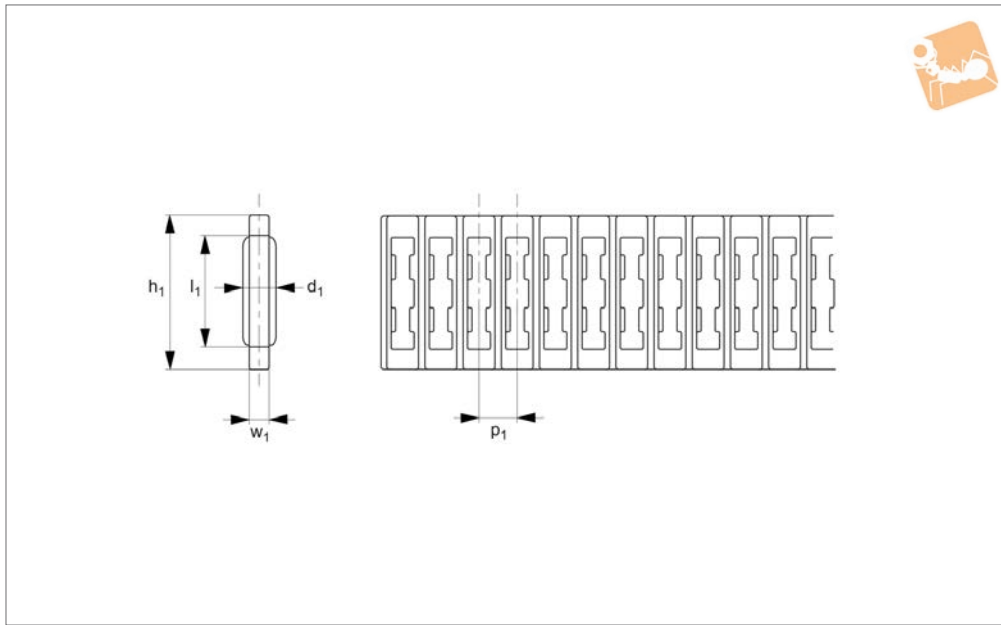

**L1009**

BALL & NEEDLE CAGES

### Material

Needle roller, steel (100Cr6 to DIN5401, grade 28, class 3), retaining cage plastic (PA 12).

### Technical Notes

When ordering please specify the length

required (must be a multiple of pitch,  $p$ ). = 225mm).  
Supplied in max. 1 metre lengths.

### Tips

Ordering example:  
L1009.050-030 is a 5mm diameter roller strip 225mm long with 30 rollers (as 30xp

Order No.	$d_1$	$p_1$	$h_1$	$l_1$	$w_1$
L1009.015-xxx	1.5	2.9	10	7.8	1.1
L1009.025-xxx	2.5	4.8	18	13.8	2.0
L1009.030-xxx	3.0	5.2	20	15.8	2.5
L1009.040-xxx	4.0	7.0	30	23.8	3.0
L1009.050-xxx	5.0	7.5	10	5.0	2.5
L1009.051-xxx	5.0	8.0	23	15.0	3.5
L1009.052-xxx	5.0	9.0	35	27.8	3.5
L1009.100-xxx	10.0	13.0	16	10.0	2.5
L1009.120-xxx	12.0	16.0	40	30.0	5.0
L1009.160-xxx	16.0	22.0	28	16.0	4.0

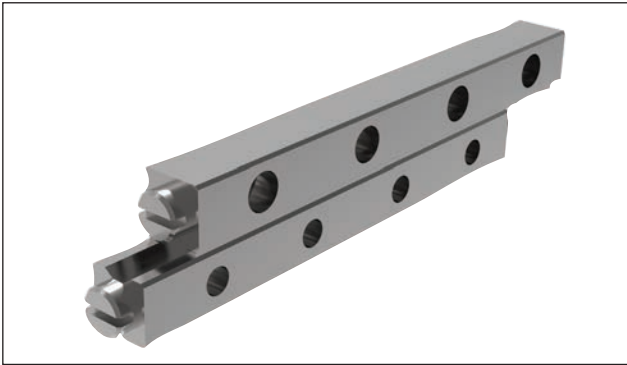

### Standard cross roller rail sets

#### L1000 & L1001

- Seven rail profiles (Sizes 1-12)
- Lengths: 20mm to 1 metre
- L1000 standard rail set
- L1001 corrosion resistant rail sets

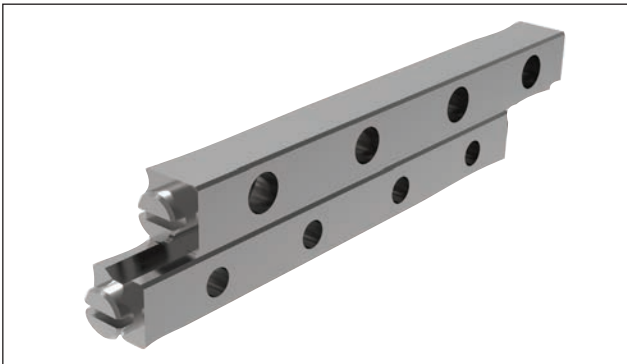

### Deep groove and anti-creep rail sets

#### L1002 + L1003

- 3 x load capacity of standard rail sets (due to deep V groove)
- Two rail profiles (Sizes 4 & 6)
- Lengths 50mm to 400mm
- Anti-creep versions for high acceleration applications



### Needle roller rail sets

#### L1004

- Heavy load ratings and needle rollers are used
- Five rail profile size
- Lengths: 200mm to 1.2 metres

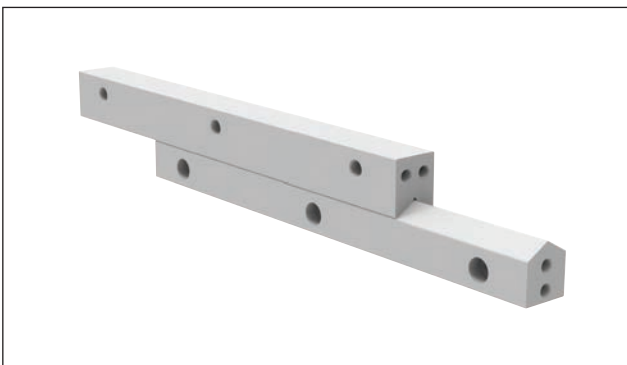

### Anti-friction coated rail sets

#### L1005 & L1006

- Same profile as needle roller rails but contact face Teflon coated.
- Ideal for harsh, dirty conditions
- Vibration damping characteristics



Our cross roller rail sets are of the highest quality.

- Close tolerance  $\pm 5\mu$
- Speeds up to 50 m/min
- Temperature range  $-40^{\circ}\text{C}$  to  $+80^{\circ}\text{C}$  up to  $+250^{\circ}\text{C}$  if applying a temperature factor
- Through hardened to  $60 \pm 2$  HRC
- Acceleration up to  $50 \text{ m/sec}^2$
- Typical 0.003 coefficient of friction dependent on mounting surface accuracy

### Expected life calculation:

$$\text{Life (Km)} L = (C/P)^{3.3} \times 1.15 \times 10^5 \text{m}$$

C = effective dynamic load (N)

P = equivalent load (N)

### Accuracy Specification:

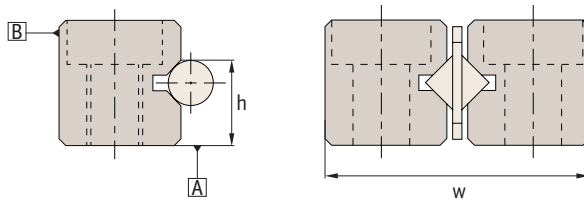

Accuracy level	
Parallelism of rolling plane A&B	graph below
Allowable height tolerance (h)	$\pm 0,02$
Paired mutual height tolerance (h)	0,01
Allowable width tolerance (w)	$+0, -0,02$

### Parallelism

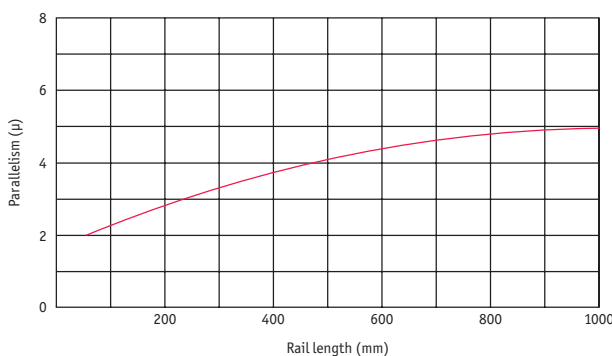

### Lubrication:

The units are lubricated with lithium soap lubricant. Relubricate if required.

### Working life calculation:

$$L_h \text{ (hours)} = \frac{L \times 10^6}{2 \times L_s \times n \times 60}$$

L = Life (Km), see above

$L_s$  = Stroke Length (mm)

n = Number of operations/min

Straightness		
Length (mm)		Straightness (μ)
Above	Below	
0	50	2,0
50	100	2,0
100	160	3,0
160	310	3,0
310	510	4,0
510	600	4,0

(Ra 0,2 μm)



### Load capacity depends on:

- Rail size
- Number of rollers in cage
- Load rating = number of rollers x load rating/roller
- Number of rollers ( $N_r$ ) = cage length ( $L_c$ ) / pitch  $p$
- Cage length affects the stroke and travel of the system

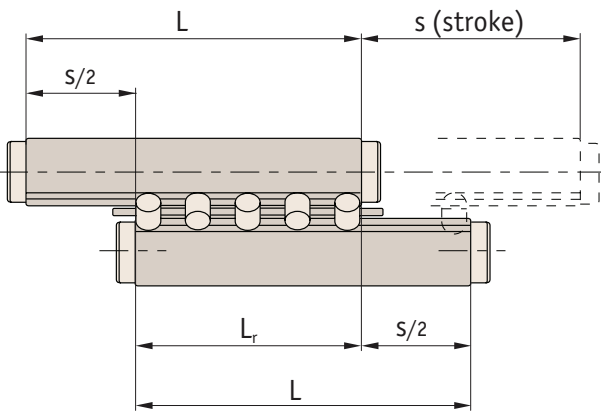

### Load calculations

Calculations of retainer length and number of rollers:

$$L_r = \frac{L - S}{2}$$

$L_r$  = distance between two rollers in ends of retainer (mm)

$L$  = rail length (mm)

$S$  = stroke length (mm)

### Worked example:

Assume L1000.09-400 with a stroke of 250mm:

Cage length =  $400 - (250/2) = 275\text{mm}$

Roller  $\varnothing = 9\text{mm}$  with a pitch (see table) of 18mm:

Number of rollers =  $275/18 = 15$

Load rating of system = load/roller\* x no. of rollers

(a pair of rollers) =  $2420\text{N} \times 15$

= 36,300N

\*See product table for allowable load per roller.

Allowable load rating with a 3x safety factor compared to static load.

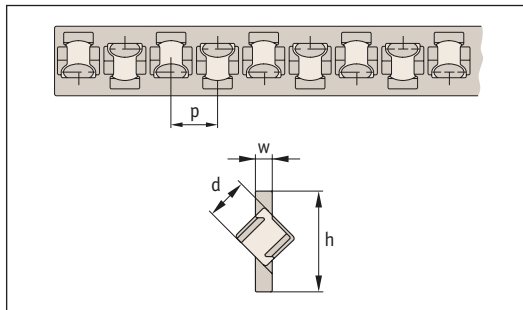

### Plastic cage



L1008.###-PR-xxx

Plastic cage with steel rollers,  
for horizontal and vertical use.

### Steel cage



L1008.###-AA-xxx

Steel cage with steel rollers,  
for horizontal use only.

Order no.	d	p	h	w	Cage material
L1008.020-PR-xxx	2	3,9	5	0,75	Plastic - black
L1008.030-PR-xxx	3	5,0	7	1,00	Plastic - black
L1008.060-PR-xxx	6	8,5	14	2,00	Plastic - black
L1008.090-PR-xxx	9	14,0	20	3,00	Plastic - black
L1008.020-AA-xxx	2	4	5,5	0,80	Steel
L1008.030-AA-xxx	3	5	7,5	0,50	Steel
L1008.060-AA-xxx	6	12	14	0,80	Steel
L1008.090-AA-xxx	9	18	19,5	1,00	Steel
L1008.120-AA-xxx	12	22	25	1,20	Steel



### Plastic cage (type PR)

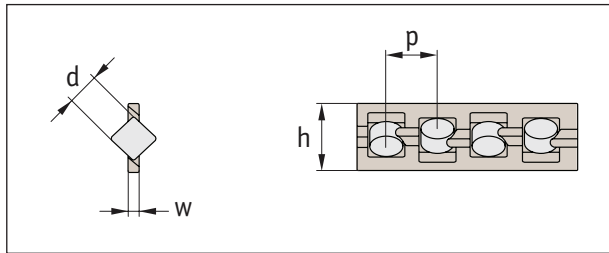

### Steel cage (type AA)

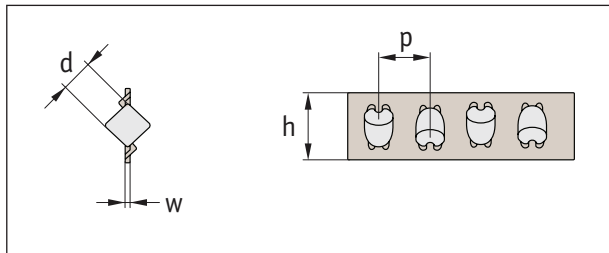

Roller load ratings (per roller)			
Rail size	Max. dynamic load $C_0$ N	Max. static load C N	Allowable* load N
1	125	144	48
2	290	290	95
3	630	760	250
4	1230	1170	390
6	2570	2630	870
9	7190	7270	2420
12	14700	13100	4300

The more rollers the greater the load capacity

\* Allowable load is 1/3 of max. static load/roller, to allow a safety factor in calculations of 3.

### End pieces

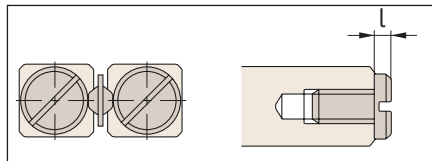

#### Type GA

- For horizontal applications, most used.

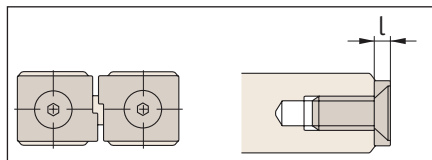

#### Type GB

- For horizontal or vertical applications.

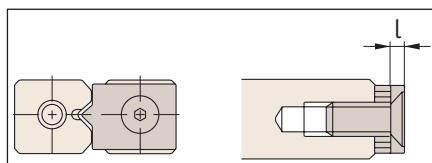

#### Type GC

- For horizontal or vertical applications.
- Mount on longer rail only.

Rail size	Type		
	GA l	GB l	GC l
1	1,5	-	-
2	2	3	-
3	2	2	3
6	3	3	5
9	3	4	6
12	3	5	8

### End screws

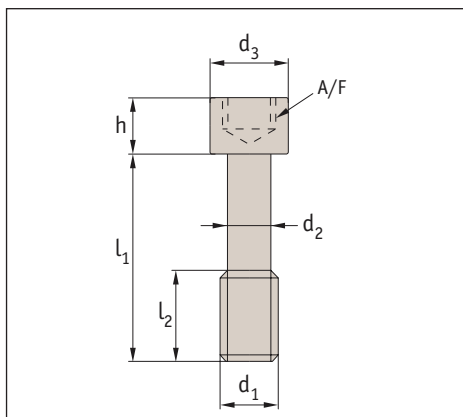

Rail	h	d <sub>1</sub>	d <sub>2</sub>	d <sub>3</sub>	l <sub>1</sub>	l <sub>2</sub>	A/F
3	3	M3	2,3	5	12	5	2,5
6	5	M5	3,9	8	20	8	4
9	6	M6	4,6	8,5	30	12	5
12	8	M8	6,25	11,3	40	17	6