

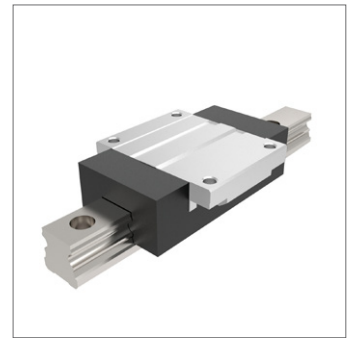

# Flanged Aluminium Carriages with retained ball cage

Linear Guide-  
ways

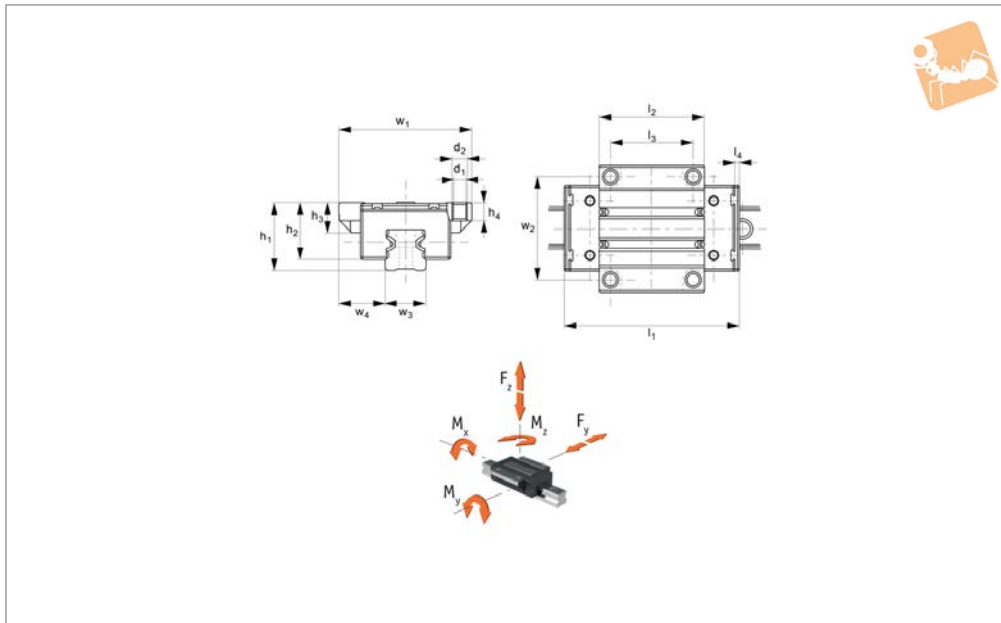

**L1018.F**

LINEAR GUIDEWAYS

### Material

Aluminium block (X46Cr13 hardened to F35), tensile strength 350N/mm<sup>2</sup>.  
Stainless steel inserts hardened, and stainless ball bearings (DIN 1.4034).

### Technical Notes

Compact, light-weight design. 60% saving versus steel versions.

Select the size and number of carriages to suit the required load then select the

required rail length, (see rail part nos. L1018). Standard carriages are not preloaded.

Mounting dimensions are identical to those of most steel linear guide rails, making them interchangeable.

### Tips

**These are aluminium rail carriages and can only be used with corresponding aluminium linear rails L1018. For stan-**

**ard steel linear guideways and carriages see part no. L1016.**

### Important Notes

Static loads ratings are difficult to calculate clearly due to the combination of materials. Do not exceed  $F_{max}$  or maximum static moment load rating. See load calculations on technical pages.

Order No.	Rail size	$l_1$	$w_1$	$h_1$ $\pm 0.03$	$d_1$	$d_2$	$h_2$	$h_3$	$h_4$	$l_2$	$l_3$	$l_4$	$w_2$	Weight kg
L1018.F15	15	64.0	47	24	4.3	M5	19.8	11	6.0	37.8	30	2.5	38	0.08
L1018.F20	20	85.9	63	30	5.3	M6	24.7	13	8.0	51.5	40	2.8	53	0.18
L1018.F25	25	96.0	70	36	6.7	M8	29.9	17	9.3	58.0	45	3.0	57	0.26

Order No.	$w_3$	$w_4$ $\pm 0.05$	F max. N	$C_0$ rad & ax N	Dyn. load C N	Dyn. moment $M_x$ Nm	Dyn. moment $M_{y \& z}$ Nm	Static moment $M_x$ Nm	Static moment $M_{y \& z}$ Nm
L1018.F15	15	16.0	2.000		5.000	36	29	14	12
L1018.F20	20	21.5	4.400		11.000	101	89	40	35
L1018.F25	23	23.5	6.400		16.000	165	147	66	59



### Product overview

Automation aluminium profile rails and ball bearing runner blocks are designed especially for all sorts of linear movements and are therefore suitable for use in most type of applications.

The rails consist of profiled aluminium, having two pressed-in hardened stainless steel shafts serving as the raceways for the balls of the runner blocks. Advantages are the light-weight and corrosive resistant materials. Fixing holes in the attachment surfaces enable machine parts to be directly mounted onto the runner blocks.

With this combination, it is possible for us to offer a guide system, which achieves a good price/performance ratio.

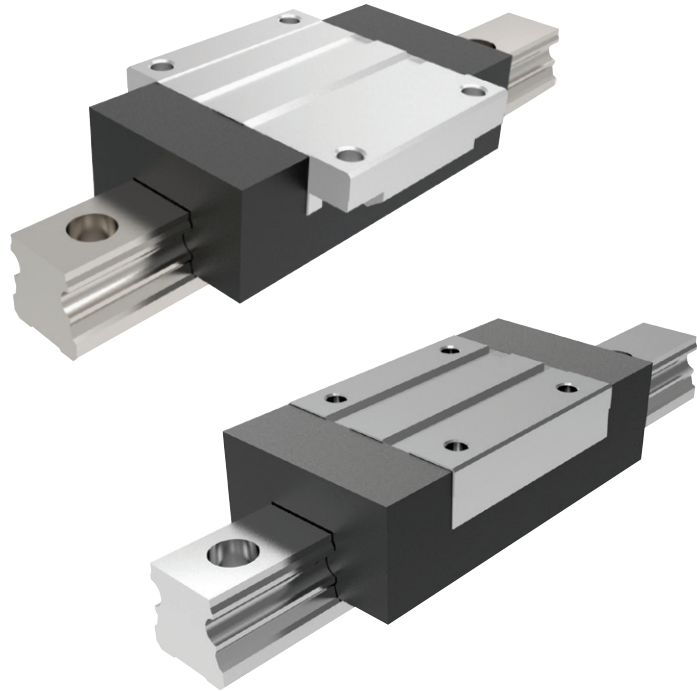

### Product range

- There are two versions of our carriages: flanged and unflanged.
- There are two accuracies for our carriages: standard precision (0) and a high precision called "P" (available on request).
- The standard carriage is not pre-loaded.
- The dynamic load rating (C in the data tables) is based on a service life of 100 Km.

### Advantages

- Compact, light-weight design with a weight saving of 60% compared to steel versions.
- Same fixing hole dimensions as steel, ball linear guideway systems.
- Much greater parallelism and height offsets of mounting bases possible, providing a degree of misalignment.
- Performs well in aggressive environments (dust, shavings etc.).
- Significantly better corrosion resistance compared to steel versions.
- Carriages initially greased in-factory, therefore provided with long-term lubrication.
- Due to ball retainers in the carriages, carriages can be removed from the rail without any loss of balls.
- Complete interchangeability between other manufacturers steel rail systems.
- Both sides of rail are reference edges. The carriages have one reference edge, which can be verified by turning it on the rail.

### Application range:

Speed	$v_{max} = 2 \text{ m/s}$
Acceleration	$a_{max} = 30 \text{ m/s}^2$
Temperature	$T = 0^\circ - 60^\circ\text{C}$

### Applications

Our rails can be used in a broad range of applications - especially in light machinery, handling technology, jigs and fixtures, assembly technology, manual displacement systems, machine enclosures, door - and window technology, display systems, aerospace, medical, food and many more.

Our aluminium rail guides cannot be used in the following applications:

- Main axis of a CNC or tooling machine.
- Aggressive and dusty environments.
- Oscillating conveyor systems.
- Danger of life or physical systems (for example unsecured overhead installation).



### Determination of the carriage size:

1. Pre-select the carriages
2. Determine  $F_{comb}$  (see below)
3. Calculate the ratio of the dynamic load capacity "C" of the selected carriages relative to  $F_{comb}$  ( $F_{comb}$  divided by "C")

If  $F_{comb}/C > 0.4$ : carriage is sized too small, select the next largest size and repeat the calculation (step 2 and 3).

The ratio must always be  $F_{comb}/C \leq 0.4$ , otherwise  $F_{max}$  will be exceeded.

#### Note:

The load ratio  $F_{comb}/C$  is the quotient of the equivalent dynamic load on the bearing divided by the dynamic load capacity "C".

### Calculation of load on bearing for a carriage:

$$F_{comb} = b \cdot \left( |F_z| + |F_y| + C \cdot \frac{|M_x|}{M_t} + C \cdot \frac{|M_y|}{M_L} + C \cdot \frac{|M_z|}{M_L} \right)$$

- $F_{comb}$  = combined equivalent load (N)
- $F_y, F_z$  = Dynamic load (N)
- $M_x$  = torque of the X-axis <sup>1)</sup> (Nm)
- $M_y$  = torque of the Y-axis <sup>2)</sup> (Nm)
- $M_z$  = Moment um die Z-Achse <sup>2)</sup> (Nm)
- $M_t$  = dynamic torsional moment load capacity (Nm)
- $M_L$  = dynamic longitudinal moment load capacity (Nm)
- C = dynamic load capacity (N)
- b = operating factor, (see below)

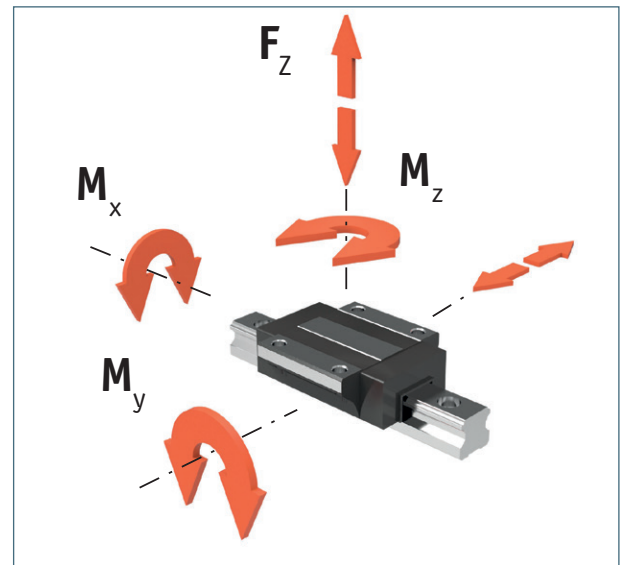

- For values, see carriage data tables
- For values, see carriage data tables
- For values, see carriage data tables
- For values, see table
- "Recommended values for operating factors "b".

- 1) Torque  $M_x$  will only be fully effective in an application with a single guide rail.
- 2) Torque  $M_y$  or  $M_x$  will only be fully effective when only a single carriage is mounted on one guide rail.

### Recommended operating factors b:

Values for operating factors b	
1,0	Clean environment, low technical demands, manual operation
1,5	In a linear motion axis with ball screw drive
2,0	Linear motion axis with toothed belt drive
6,0	Linear motion axis with pneumatic drive
9,0	In very dirty environments

### Static load rating

A static load rating can not be easily determined, because of the composite material (aluminium/stainless steel combination). Instead of this, you can find the values  $F_{max}$  and  $M_{max}$ .



### Parallelism

Please note the parallelism is required in the structure for correct installation. Parallelism of the installed rails is measured at the guide rails and the carriages. Any parallelism offset will cause a slight increase in preload on one side of the assembly. As long as values specified in the table are met, the effect of parallelism offsets on the service life can generally be neglected.

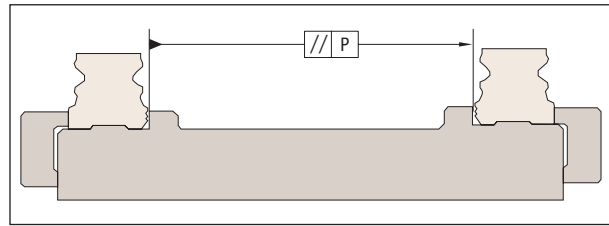

Size	Permissible deviation in parallelism $P_{max}$	
	Standard	Preload
15	0,027	0,018
20	0,031	0,021
25	0,034	0,022

mm

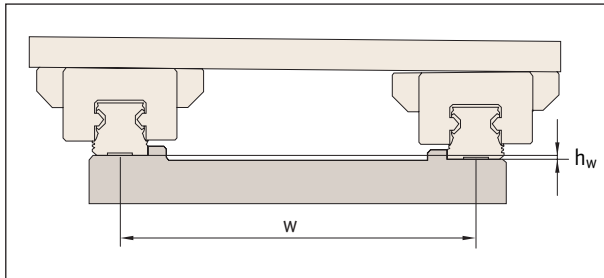

Calculation factor f	Standard	Preload
	$1,2 \cdot 10^{-3}$	$0,75 \cdot 10^{-3}$

### Height deviation

Permissible height deviation in lateral direction " $h_w$ "

$$h_w \leq w \cdot f$$

$h_w$  = Allowable height deviation (mm)  
 $w$  = Distance between rails (mm)  
 $f$  = Calculation factor

### Allowable height deviation in longitudinal direction

Allowable height deviation in longitudinal direction " $h_l$ "

$$h_l \leq b \cdot g$$

$h_l$  = Permissible height deviation (mm)  
 $b$  = Distance between carriages (mm)  
 $g$  = Calculation factor

$$h_l = L \times [6 \times 10^{-4}]$$

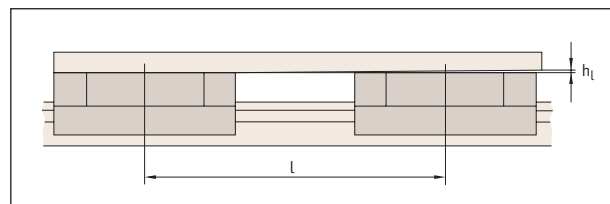

Calculation factor g	Standard	Preload
	$6 \times 10^{-4}$	$2,1 \times 10^{-4}$



### Height tolerance "H"

The height tolerance of several carriages on a rail is maximum  $\pm 30\mu$ . In a combination of several carriages and rails the maximum is  $\pm 120\mu$ .

### Side tolerance "D"

The maximum side tolerance of several carriages on a rail is  $\pm 30\mu$ . In a combination of several carriages and rails, the maximum is  $\pm 70\mu$ .

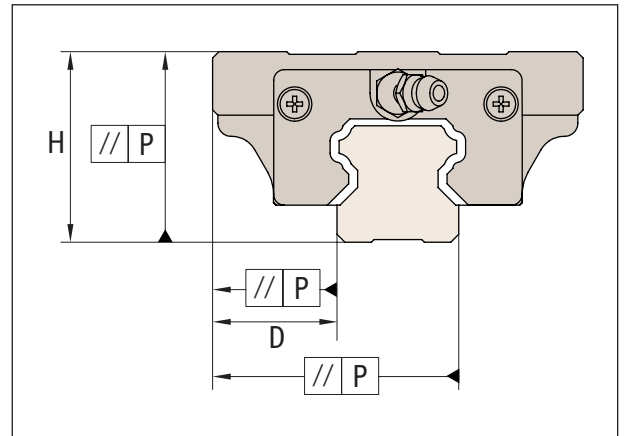

### Deviation of parallelism

