

Crossed Roller Tables

steel

Linear Tables

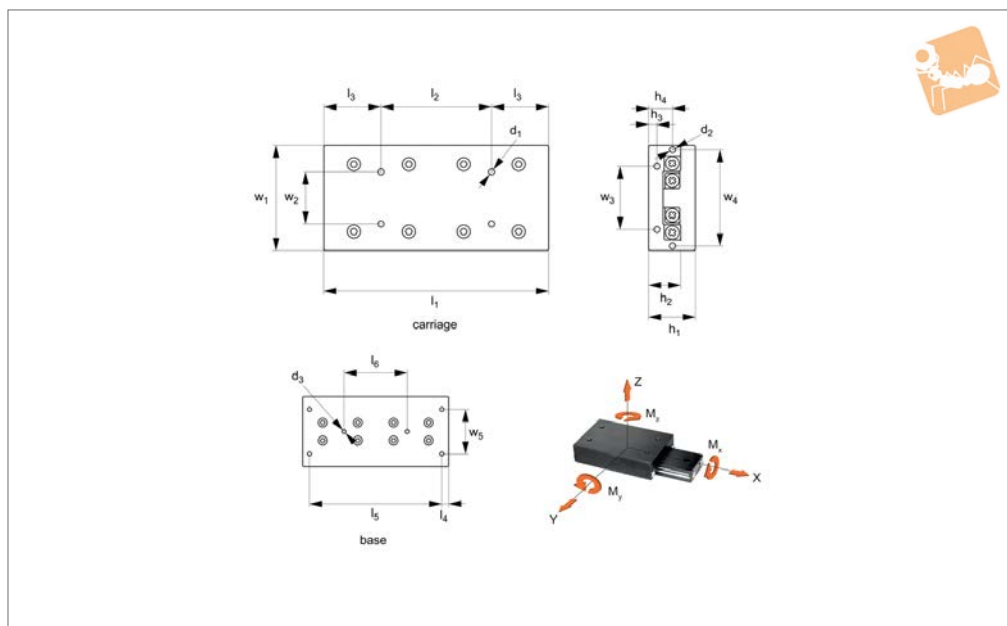

L1020

LINEAR TABLES

Material

Body carbon steel (S50C) nickel plated.
Rail and rollers carbon steel (100Cr6),
retainer stainless steel (AISI 304).

Technical Notes

Base and carriage with standard hole

pattern. The top can be machined as required, taking care to disassemble first and ensure no dirt ingress.

Alternatively we can machine any extra holes required (additional cost).
Recommended allowable load is 1/3 of

max. static load giving a safety factor of over 3.

Tips

Stroke is centred on the mid-point of the slides (ie 50% of total stroke each way).

Order No.	Static load C_0 kN max.	Stroke	Roller	w_1 ± 0.1	l_2	h_1 ± 0.1	h_2	l_1	w_2	d_1	l_3	l_4	w_3	Weight kg
L1020.030-025	0.57	12	1.5	30	-	17	11	25	10	M2x4	12.5	3.5	12	0.04
L1020.030-035	0.86	18	1.5	30	10	17	11	35	10	M2x4	12.5	3.5	12	0.05
L1020.030-045	1.1	25	1.5	30	10	17	11	45	10	M2x4	12.5	3.5	12	0.07
L1020.030-055	1.4	32	1.5	30	10	17	11	55	10	M2x4	12.5	3.5	12	0.08
L1020.030-065	1.7	40	1.5	30	10	17	11	65	10	M2x4	12.5	3.5	12	0.10
L1020.030-075	2.3	45	1.5	30	10	17	11	75	10	M2x4	12.5	3.5	12	0.12
L1020.030-085	2.6	50	1.5	30	10	17	11	85	10	M2x4	12.5	3.5	12	0.13
L1020.040-035	1.1	18	2.0	40	-	21	14	35	15	M3x6	17.5	5.0	16	0.09
L1020.040-050	2.3	30	2.0	40	15	21	14	50	15	M3x6	17.5	5.0	16	0.13
L1020.040-065	2.9	40	2.0	40	15	21	14	65	15	M3x6	17.5	5.0	16	0.17
L1020.040-080	3.5	50	2.0	40	15	21	14	80	15	M3x6	17.5	5.0	16	0.21
L1020.040-095	4.0	60	2.0	40	15	21	14	95	15	M3x6	17.5	5.0	16	0.25
L1020.040-110	5.2	70	2.0	40	15	21	14	110	15	M3x6	17.5	5.0	16	0.30
L1020.040-125	5.8	80	2.0	40	15	21	14	125	15	M3x6	17.5	5.0	16	0.34
L1020.040-140	6.4	90	2.0	40	15	21	14	140	15	M3x6	17.5	5.0	16	0.38
L1020.040-155	7.0	100	2.0	40	15	21	14	155	15	M3x6	17.5	5.0	16	0.42
L1020.040-170	8.1	110	2.0	40	15	21	14	170	15	M3x6	17.5	5.0	16	0.46
L1020.040-185	8.8	120	2.0	40	15	21	14	185	15	M3x6	17.5	5.0	16	0.50
L1020.060-055	4.5	30	3.0	60	-	28	18.5	55	25	M4x8	27.5	10.0	40	0.29
L1020.060-080	7.6	45	3.0	60	25	28	18.5	80	25	M4x8	27.5	10.0	40	0.43
L1020.060-105	10.6	60	3.0	60	25	28	18.5	105	25	M4x8	27.5	10.0	40	0.57
L1020.060-130	12.1	75	3.0	60	25	28	18.5	130	25	M4x8	27.5	10.0	40	0.71
L1020.060-155	15.2	90	3.0	60	25	28	18.5	155	25	M4x8	27.5	10.0	40	0.84
L1020.060-180	18.2	105	3.0	60	25	28	18.5	180	25	M4x8	27.5	10.0	40	0.98
L1020.060-205	19.7	130	3.0	60	25	28	18.5	205	25	M4x8	27.5	10.0	40	1.12
L1020.060-230	21.3	155	3.0	60	25	28	18.5	230	25	M4x8	27.5	10.0	40	1.25
L1020.060-255	24.3	180	3.0	60	25	28	18.5	255	25	M4x8	27.5	10.0	40	1.39
L1020.060-280	25.8	205	3.0	60	25	28	18.5	280	25	M4x8	27.5	10.0	40	1.53
L1020.060-305	27.4	230	3.0	60	25	28	18.5	305	25	M4x8	27.5	10.0	40	1.66
L1020.080-085	9.3	50	4.0	80	-	35	24.0	85	40	M5x10	42.5	10.5	55	0.76



LINEAR TABLES

Order No.	Static load C_0 kN max.	Stroke	Roller	w_1 ± 0.1	l_2	h_1 ± 0.1	h_2	l_1	w_2	d_1	l_3	l_4	w_3	Weight kg
L1020.080-125	14.0	75	4.0	80	40	35	24.0	125	40	M5x10	42.5	10.5	55	1.12
L1020.080-165	16.3	105	4.0	80	40	35	24.0	165	40	M5x10	42.5	10.5	55	1.48
L1020.080-205	21.0	130	4.0	80	40	35	24.0	205	40	M5x10	42.5	10.5	55	1.84
L1020.080-245	25.7	155	4.0	80	40	35	24.0	245	40	M5x10	42.5	10.5	55	2.20
L1020.080-285	30.4	185	4.0	80	40	35	24.0	285	40	M5x10	42.5	10.5	55	2.56
L1020.080-325	35.0	210	4.0	80	40	35	24.0	325	40	M5x10	42.5	10.5	55	2.92
L1020.080-365	39.7	235	4.0	80	40	35	24.0	365	40	M5x10	42.5	10.5	55	3.28
L1020.080-405	44.4	265	4.0	80	40	35	24.0	405	40	M5x10	42.5	10.5	55	3.65
L1020.100-110	21.0	60	6.0	100	50	45	31.0	110	50	M6x12	55.0	10.0	60	1.60
L1020.100-160	26.3	95	6.0	100	50	45	31.0	160	50	M6x12	55.0	10.0	60	2.36
L1020.100-210	36.8	130	6.0	100	50	45	31.0	210	50	M6x12	55.0	10.0	60	3.11
L1020.100-260	47.3	165	6.0	100	50	45	31.0	260	50	M6x12	55.0	10.0	60	3.86
L1020.100-310	57.8	200	6.0	100	50	45	31.0	310	50	M6x12	55.0	10.0	60	4.62
L1020.100-360	68.4	235	6.0	100	50	45	31.0	360	50	M6x12	55.0	10.0	60	5.36
L1020.100-410	78.9	265	6.0	100	50	45	31.0	410	50	M6x12	55.0	10.0	60	6.12
L1020.100-460	84.2	300	6.0	100	50	45	31.0	460	50	M6x12	55.0	10.0	60	6.87
L1020.100-510	94.7	335	6.0	100	50	45	31.0	510	50	M6x12	55.0	10.0	60	7.62

Order No.	w_4	l_5	h_3	l_6	h_4	d_2	w_7	d_3	Dyn. load C kN max.	Allowable load kN	Moment M_x Nm max.	Moment M_y Nm max.	Moment M_z Nm max.
L1020.030-025	-	18	2.5	-	-	M2x6	22	4.5	0.38	0.19	2.6	1.2	1.4
L1020.030-035	-	28	2.5	-	-	M2x6	22	4.5	0.52	0.28	3.9	2.6	3.0
L1020.030-045	-	38	2.5	-	-	M2x6	22	4.5	0.65	0.38	5.2	4.6	5.2
L1020.030-055	-	48	2.5	-	-	M2x6	22	4.5	0.78	0.48	6.5	7.2	7.9
L1020.030-065	-	58	2.5	-	-	M2x6	22	4.5	0.90	0.57	7.8	10.4	11.2
L1020.030-075	-	68	2.5	-	-	M2x6	22	4.5	1.1	0.77	10.4	18.4	17.3
L1020.030-085	-	78	2.5	-	-	M2x6	22	4.5	1.2	0.86	11.7	23.3	22.0
L1020.040-035	-	25	3.4	-	-	M2x6	30	6.5	0.89	0.39	7.0	3.1	3.9
L1020.040-050	-	40	3.4	-	-	M2x6	30	6.5	1.5	0.78	14.0	12.5	10.9
L1020.040-065	-	55	3.4	-	-	M2x6	30	6.5	1.8	0.98	17.5	19.5	17.5
L1020.040-080	-	70	3.4	-	-	M2x6	30	6.5	2.1	1.1	21.1	28.1	30.4
L1020.040-095	-	85	3.4	-	-	M2x6	30	6.5	2.4	1.3	24.6	38.2	40.9
L1020.040-110	-	100	3.4	-	-	M2x6	30	6.5	2.9	1.7	31.6	63.2	59.6
L1020.040-125	-	115	3.4	-	-	M2x6	30	6.5	3.1	1.9	35.1	78.0	74.1
L1020.040-140	-	130	3.4	-	-	M2x6	30	6.5	3.4	2.1	38.6	94.3	98.6
L1020.040-155	-	145	3.4	-	-	M2x6	30	6.5	3.6	2.3	42.1	112	111
L1020.040-170	-	160	3.4	-	-	M2x6	30	6.5	4.1	2.7	49.1	152	147
L1020.040-185	-	175	3.4	-	-	M2x6	30	6.5	4.3	2.9	52.6	175	169
L1020.060-055	-	35	5.5	-	-	M3x6	40	8.0	2.9	1.5	42.6	22.8	26.6
L1020.060-080	-	60	5.5	-	-	M3x6	40	8.0	4.3	2.5	71.0	63.4	57.1
L1020.060-105	-	85	5.5	-	-	M3x6	40	8.0	5.6	3.5	99.5	124	115
L1020.060-130	-	110	5.5	-	-	M3x6	40	8.0	6.2	4.0	113	162	172
L1020.060-155	-	135	5.5	85	-	M3x6	40	8.0	7.4	5.0	142	253	266
L1020.060-180	-	160	5.5	110	-	M3x6	40	8.0	8.6	6.0	170	365	350
L1020.060-205	-	185	5.5	135	-	M3x6	40	8.0	9.1	6.6	184	428	445
L1020.060-230	-	210	5.5	160	-	M3x6	40	8.0	9.7	7.1	198	497	515
L1020.060-255	-	235	5.5	185	-	M3x6	40	8.0	10.7	8.1	227	649	629
L1020.060-280	-	260	5.5	210	-	M3x6	40	8.0	11.2	8.6	241	733	711
L1020.060-305	-	285	5.5	235	-	M3x6	40	8.0	11.8	9.1	255	822	844
L1020.080-085	-	65	6.5	-	-	M3x6	55	10.0	6.6	3.1	124	87.3	76.4
L1020.080-125	-	105	6.5	-	-	M3x6	55	10.0	9.0	4.6	187	196	180
L1020.080-165	-	145	6.5	-	-	M3x6	55	10.0	10.2	5.4	218	267	286
L1020.080-205	-	185	6.5	105	-	M3x6	55	10.0	12.5	7.0	280	442	466
L1020.080-245	-	225	6.5	145	-	M3x6	55	10.0	14.6	8.6	343	660	690
L1020.080-285	-	265	6.5	185	-	M3x6	55	10.0	16.6	10.1	405	922	957
L1020.080-325	-	305	6.5	225	-	M3x6	55	10.0	18.6	11.7	467	1128	1269
L1020.080-365	-	345	6.5	265	-	M3x6	55	10.0	20.5	13.2	530	1577	1623
L1020.080-405	-	385	6.5	305	-	M3x6	55	10.0	22.3	14.8	592	1970	1918
L1020.100-110	92	90	8.0	-	15	M4x8	60	11.5	13.9	7.0	315	252	221
L1020.100-160	92	140	8.0	-	15	M4x8	60	11.5	16.5	8.7	394	394	434
L1020.100-210	92	190	8.0	90	15	M4x8	60	11.5	21.6	12.2	552	773	828
L1020.100-260	92	240	8.0	140	15	M4x8	60	11.5	26.2	15.7	710	1279	1207
L1020.100-310	92	290	8.0	190	15	M4x8	60	11.5	30.7	19.3	868	1910	1823
L1020.100-360	92	340	8.0	240	15	M4x8	60	11.5	35.0	22.8	1026	2688	2565
L1020.100-410	92	390	8.0	290	15	M4x8	60	11.5	39.1	26.3	1184	3552	3434
L1020.100-460	92	440	8.0	340	15	M4x8	60	11.5	41.1	28.0	1263	4042	4168

Crossed Roller Tables

steel

Linear Tables



Order No.	w ₄	l ₅	h ₃	l ₆	h ₄	d ₂	w ₇	d ₃	Dyn. load C kN max.	Allowable load kN	Moment M _x Nm max.	Moment M _y Nm max.	Moment M _z Nm max.
L1020.100-510	92	490	8.0	390	15	M4x8	60	11.5	45.1	31.5	1421	5115	5257

LINEAR TABLES



Size + Weight

For light/medium loads

L1020-L1037

Ball roller versions



L1024 - L1038

Cross roller versions



L1020 - L1026

Stainless steel versions



L1022 - L1023

For heavy duty loads and motorised

L3000-L3500

Needle roller & dovetail stage

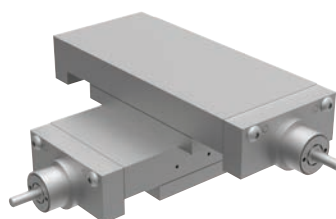

L3170 - L3194

Motorised stages



L3500 - L3510

Micrometer driven stages



L3100 - L3123

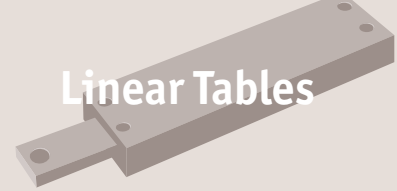

Factors affecting stage selections...

- Size and weight of load
- Moment loads
- Stroke required
- Accuracy required
- Usage conditions of water, chemicals, shock loads etc.

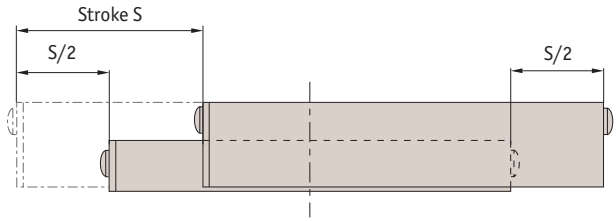

Generally ball slides are less expensive but cross roller slides can carry 8 to 10 times the load of ball slides.

The stroke is centred on the mid point of the slides (i.e. 50% of the stroke each way).

LINEAR TABLES

A selection...		
<p>L1020 Crossed roller tables</p>  <p>Steel and aluminium, accuracy typically 5μ.</p>	<p>L1022/23 Cross roller table</p>  <p>Stainless Steel, accuracy typically 3μ.</p>	<p>L1024 Ball slide tables</p>  <p>Aluminium, accuracy typically 12μ.</p>
<p>L1026 Crossed roller slide tables</p>  <p>Aluminium, accuracy typically 5μ.</p>	<p>L1028 Precision ball slide tables</p>  <p>Aluminium, accuracy typically 3μ.</p>	<p>L1029 Precision crossed roller tables</p>  <p>Aluminium, accuracy typically 3μ.</p>
<p>L1034 Flanged ball slide tables - precision</p>  <p>With flange accuracy to 1μ.</p>	<p>L1038 Anti-creep ball slide tables</p>  <p>Special anti-creep function prevents cage misalignment.</p>	<p>L1039 Non-magnetic ball slide</p>  <p>Non-magnetic accuracy typically 3μ.</p>



Steel - L1020

- Standard steel / cast iron



Aluminium - L1021

- Lower weight, lower profile
- Good for high accelerations



Stainless steel - L1022 + L1023

- Stainless steel (440C+Ni) corrosion resistant

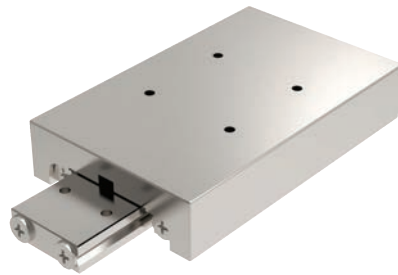

Rated life

$$L \text{ (Km)} = \left(\frac{F_t \cdot C}{F_w \cdot P_c} \right)^{3.33} \times 100$$

- F_t = temperature factor
- F_w = load factor
- C = basic dynamic load (kN) see tables
- P_c = radial load (kN)

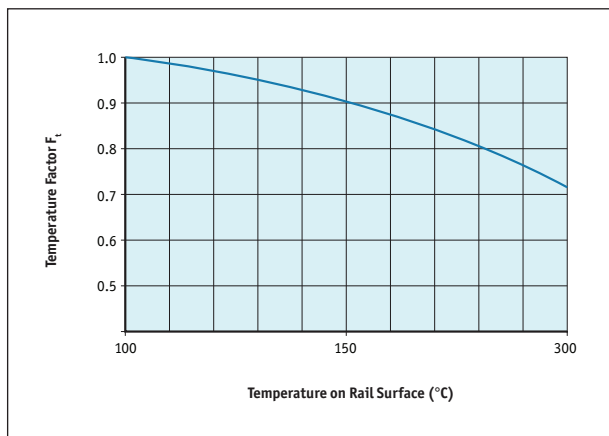
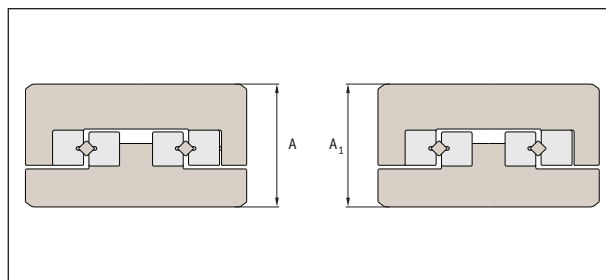

Height tolerance:

- Height $\pm 100\mu$
- Motorised parts $\pm 10\mu$
- Strokes from 10 to 950mm
- Loads to 48kN

Load factor F_w

Shock	Speed	F_w
None	Very slow	1.0 - 1.2
Small	Slow	1.2 - 1.5

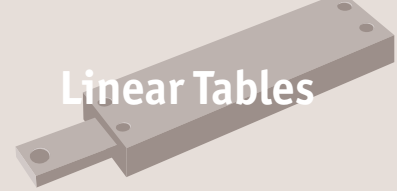

Technical accuracy measurements

- High accuracy.
- Low friction: virtually frictionless. Providing stable performance at lower high speeds.
- Rigid: incorporating cross roller linear rails to provide high load capacity as well as high moment load capacity.
- Installation: easy to install with pre-drilled holes in carriage and base. Ensure mounting surface faces are accurately machined.

Table length	Table accuracy (μ)		Rail accuracy (μ)		
	Carriage top parallelism	Carriage side parallelism	N tolerance	M tolerance	Straightness
0-50	2	4	-15 -35	-30 -70	2
50-100	2	5			2
100-150	3	6			3
150-200	3	7			3
200-250	3	7			3
250-300	3	7			3
300-350	4	8			4
350-400	4	8			4
400-450	4	8			4
450-500	4	8			4
500-550	4	9			4
550-600	4	9			4

