

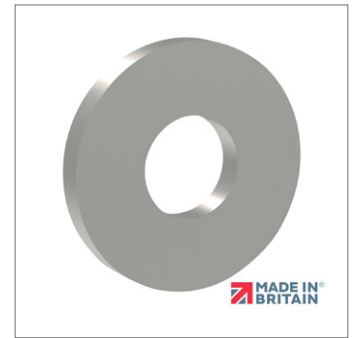

# Threaded Captive Washers for captive screws

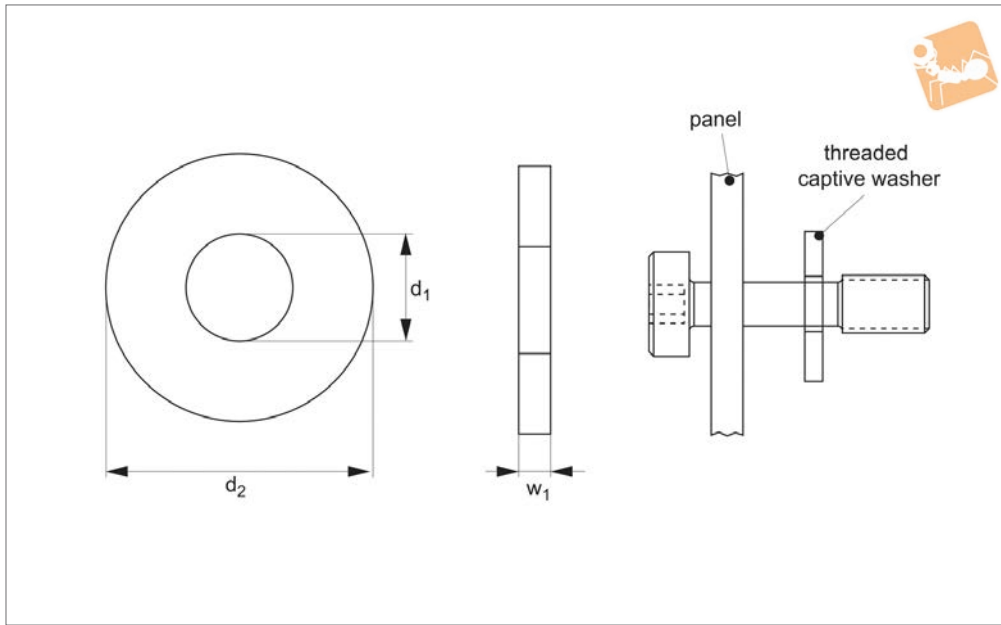

Captive Screws



**P0168**

CAPTIVE SCREWS

### Material

Stainless steel (AISI 303, 1.4305 and AISI 316, 1.440), steel (zinc-plated or black-oxide) and titanium (grade 2 and grade 5).

### Technical Notes

Captive washers have a very shallow thread on the i/d.

This enables them to be screwed on, and once past the threads they do not separate from the captive screw or bolt.

### Tips

Captive washers are primarily used to retain captive screws in panels which have

unthreaded holes. The panel (onto which the screw needs to be retained) is placed onto the captive screw, the threaded washer is then threaded onto the screw, past the threaded section and the screw is therefore captive to the panel.

Order No.	d <sub>1</sub>	w <sub>1</sub> ±0.05	d <sub>2</sub>	Material
P0168.025-A2	M 2,5	1.0	5.0	Stainless steel 303
P0168.030-A2	M 3	1.0	6.0	Stainless steel 303
P0168.035-A2	M 3,5	1.2	8.0	Stainless steel 303
P0168.040-A2	M 4	1.2	8.0	Stainless steel 303
P0168.050-A2	M 5	1.5	10.0	Stainless steel 303
P0168.060-A2	M 6	1.6	12.0	Stainless steel 303
P0168.080-A2	M 8	2.0	16.0	Stainless steel 303
P0168.100-A2	M10	3.0	20.0	Stainless steel 303
P0168.120-A2	M12	3.5	24.0	Stainless steel 303
P0168.160-A2	M16	4.0	32.0	Stainless steel 303
P0168.200-A2	M20	5.0	40.0	Stainless steel 303
P0168.025-A4	M 2,5	1.0	5.0	Stainless steel 316
P0168.030-A4	M 3	1.0	6.0	Stainless steel 316
P0168.035-A4	M 3,5	1.2	8.0	Stainless steel 316
P0168.040-A4	M 4	1.2	8.0	Stainless steel 316
P0168.050-A4	M 5	1.5	10.0	Stainless steel 316
P0168.060-A4	M 6	1.6	12.0	Stainless steel 316
P0168.080-A4	M 8	2.0	16.0	Stainless steel 316
P0168.100-A4	M10	3.0	20.0	Stainless steel 316
P0168.120-A4	M12	3.5	24.0	Stainless steel 316
P0168.160-A4	M16	4.0	32.0	Stainless steel 316
P0168.200-A4	M20	5.0	40.0	Stainless steel 316
P0168.025-B2	M 2,5	1.0	5.0	Blackened stainless 303
P0168.030-B2	M 3	1.0	6.0	Blackened stainless 303
P0168.035-B2	M 3,5	1.2	8.0	Blackened stainless 303
P0168.040-B2	M 4	1.2	8.0	Blackened stainless 303
P0168.050-B2	M 5	1.5	10.0	Blackened stainless 303
P0168.060-B2	M 6	1.6	12.0	Blackened stainless 303
P0168.080-B2	M 8	2.0	16.0	Blackened stainless 303
P0168.100-B2	M10	3.0	20.0	Blackened stainless 303



CAPTIVE SCREWS

Order No.	d <sub>1</sub>	w <sub>1</sub> ±0.05	d <sub>2</sub>	Material
P0168.120-B2	M12	3.5	24.0	Blackened stainless 303
P0168.160-B2	M16	4.0	32.0	Blackened stainless 303
P0168.200-B2	M20	5.0	40.0	Blackened stainless 303
P0168.025-B4	M 2,5	1.0	5.0	Blackened stainless 316
P0168.030-B4	M 3	1.0	6.0	Blackened stainless 316
P0168.035-B4	M 3,5	1.2	8.0	Blackened stainless 316
P0168.040-B4	M 4	1.2	8.0	Blackened stainless 316
P0168.050-B4	M 5	1.5	10.0	Blackened stainless 316
P0168.060-B4	M 6	1.6	12.0	Blackened stainless 316
P0168.080-B4	M 8	2.0	16.0	Blackened stainless 316
P0168.100-B4	M10	3.0	20.0	Blackened stainless 316
P0168.120-B4	M12	3.5	24.0	Blackened stainless 316
P0168.160-B4	M16	4.0	32.0	Blackened stainless 316
P0168.200-B4	M20	5.0	40.0	Blackened stainless 316
P0168.025-ZP	M 2,5	1.0	5.0	Zinc-plated steel
P0168.030-ZP	M 3	1.0	6.0	Zinc-plated steel
P0168.035-ZP	M 3,5	1.2	8.0	Zinc-plated steel
P0168.040-ZP	M 4	1.2	8.0	Zinc-plated steel
P0168.050-ZP	M 5	1.5	10.0	Zinc-plated steel
P0168.060-ZP	M 6	1.6	12.0	Zinc-plated steel
P0168.080-ZP	M 8	2.0	16.0	Zinc-plated steel
P0168.100-ZP	M10	3.0	20.0	Zinc-plated steel
P0168.120-ZP	M12	3.5	24.0	Zinc-plated steel
P0168.160-ZP	M16	4.0	32.0	Zinc-plated steel
P0168.200-ZP	M20	5.0	40.0	Zinc-plated steel
P0168.025-BL	M 2,5	1.0	5.0	Blackened steel
P0168.030-BL	M 3	1.0	6.0	Blackened steel
P0168.035-BL	M 3,5	1.2	8.0	Blackened steel
P0168.040-BL	M 4	1.2	8.0	Blackened steel
P0168.050-BL	M 5	1.5	10.0	Blackened steel
P0168.060-BL	M 6	1.6	12.0	Blackened steel
P0168.080-BL	M 8	2.0	16.0	Blackened steel
P0168.100-BL	M10	3.0	20.0	Blackened steel
P0168.120-BL	M12	3.5	24.0	Blackened steel
P0168.160-BL	M16	4.0	32.0	Blackened steel
P0168.200-BL	M20	5.0	40.0	Blackened steel
P0168.025-T2	M 2,5	1.0	5.0	Grade 2 titanium
P0168.030-T2	M 3	1.0	6.0	Grade 2 titanium
P0168.035-T2	M 3,5	1.2	8.0	Grade 2 titanium
P0168.040-T2	M 4	1.2	8.0	Grade 2 titanium
P0168.050-T2	M 5	1.5	10.0	Grade 2 titanium
P0168.060-T2	M 6	1.6	12.0	Grade 2 titanium
P0168.080-T2	M 8	2.0	16.0	Grade 2 titanium
P0168.100-T2	M10	3.0	20.0	Grade 2 titanium
P0168.120-T2	M12	3.5	24.0	Grade 2 titanium
P0168.160-T2	M16	4.0	32.0	Grade 2 titanium
P0168.200-T2	M20	5.0	40.0	Grade 2 titanium
P0168.025-T5	M 2,5	1.0	5.0	Grade 5 titanium
P0168.030-T5	M 3	1.0	6.0	Grade 5 titanium
P0168.035-T5	M 3,5	1.2	8.0	Grade 5 titanium
P0168.040-T5	M 4	1.2	8.0	Grade 5 titanium
P0168.050-T5	M 5	1.5	10.0	Grade 5 titanium
P0168.060-T5	M 6	1.6	12.0	Grade 5 titanium
P0168.080-T5	M 8	2.0	16.0	Grade 5 titanium
P0168.100-T5	M10	3.0	20.0	Grade 5 titanium
P0168.120-T5	M12	3.5	24.0	Grade 5 titanium
P0168.160-T5	M16	4.0	32.0	Grade 5 titanium
P0168.200-T5	M20	5.0	40.0	Grade 5 titanium



## Coatings

Wixroyd produce a wide range of fasteners designed for application where it is important that fasteners are not separated from equipment (e.g. cover panels etc). This is now important to ensure that equipment complies with Machinery Directive 200642/EC - requiring that fasteners remain attached to fixed guards or equipment when guards are removed.





Our captive panel screws are manufactured mainly from stainless steel (AISI 303, 1.4305 grade), but they can also be produced in stainless steel (A4, AISI 316), aluminium, brass or zinc plated steel.

Many finishes can be applied - black oxide finish, anodizing etc.

The main options are as follows:

Finish	Notes
Black Chrome (MIL-C-1458B)	Black chrome is a hard, non-reflective coating which is resistant to abrasion, heat and corrosion. The black chrome surface is a dull, dark grey and may be waxed or oiled to darken surface.
Black Oxide Coating (MIL-C-13924B)	Black oxide is a uniform black coating for ferrous metals. Generally it is considered a decorative coating and provides only very limited corrosion protection under mild corrosion conditions.
Cadmium	Cadmium is a bright, silvery white plating. Supplementary treatments for Type II can be golden, iridescent, amber, black or olive drab.
Passivate (QQ-P-35/MIL S-500SC)	Passivation is a process designed to remove foreign metals from the surface of stainless and corrosion resistant steels.
Phosphate Coating Light (TT-C-00490B)	Phosphate coating is a light coating for use as a base paint.
Gold (MIL-G-45204B)	Yellow to orange colour depending on proprietary process used. Will range from matt to bright finish depending on base metal. Good corrosion resistance and high tarnish resistance.
Nickel (QQ-N-290A)	Nickel is a corrosion protective plating for steel, zinc and zinc alloys as well as copper and copper alloys.
Zinc (QQ-Z-325C)	The primary use of chromate finishes on zinc is to retard or prevent formation of white corrosion products on zinc surfaces.

## Drive Types

Schematic	Drive Types	Uses
	Hexagonal	Ideal for precision assembly. Most recommended where less surface area is available.
	Crosshead (Phillips®)	Provides good control in driving. Always use a driver bit of the proper size which is in good condition.
	Hexalobular (Torx®)	Positive-engaging, fast-locating method which transmits drive torque with less required downward pressure. Good fastening appearance.
	Slotted	Accepts standard blade screwdriver. Requires less downward pressure to drive parts than those with recessed openings. Use a proper fitting blade to minimize slippage.
	Security	These screws are impossible to remove without the special matching screw driver.



**36681** - Cap head - hex. socket



**36682** - Cap head - hex. socket Security and Torx® options

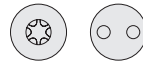

**36683** - Pan Head - Phillips® Security and Torx® options

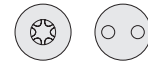

**36684** - Countersunk - hex. socket Security and Torx® options

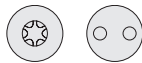

**36686** - Thin head thumb screw



**36687** - Thumb screw



**36691** - Threaded captive washers

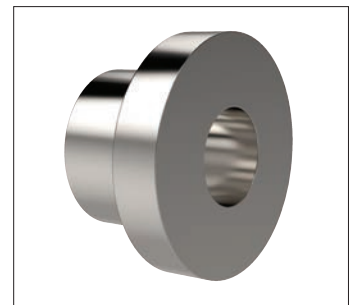

**36692** - Retainer flanges



One option to retain screws to panels are our retaining washers. Used in place of retainer flanges, retaining washers are simple but effective when used with our captive screws. The captive screws have a normal thread then a reduced diameter for the rest of the screw length.

The retaining washer has a small length of thread on the internal diameter and once screwed on to the captive screw is effectively captive.

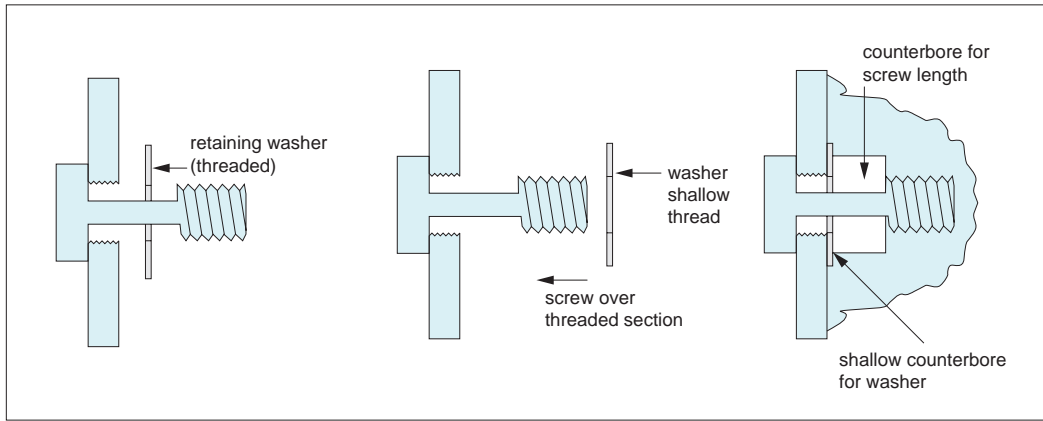

## Example

Screw the thin retaining washer onto the captive screw and the screw is therefore retained to the panel.

