

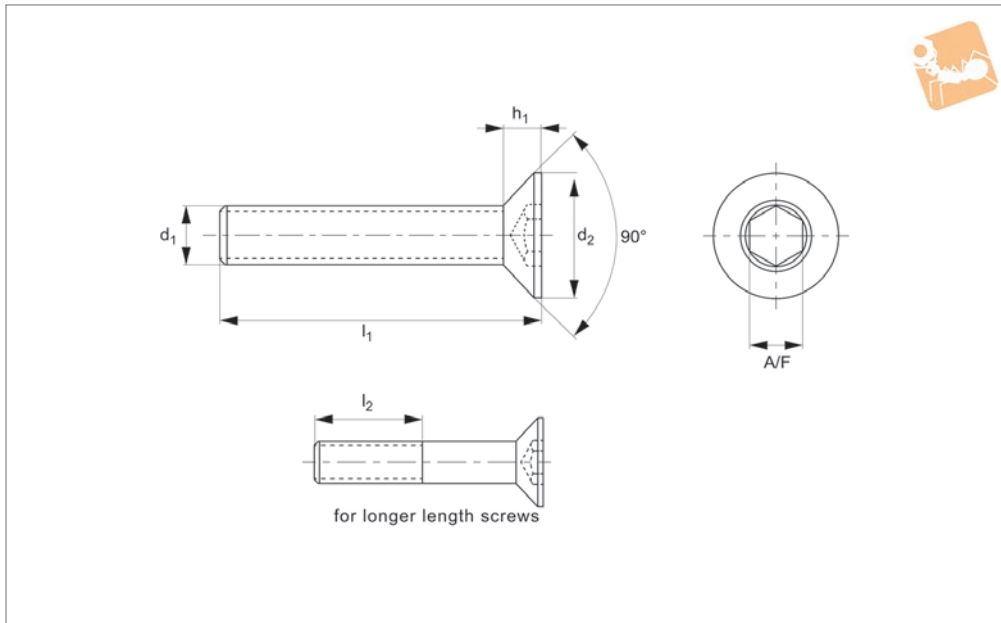

Socket Countersunk Machine Screws

Socket - A2 stainless

Standard Screws



P0222.A2

STANDARD SCREWS

Material

Stainless steel A2.

Technical Notes

To DIN 7991, ISO 10642. For the majority

of screw lengths the threads goes all the way to the head of the screw (i.e. $l_1 = l_2$) less 2.5 thread pitches.
For longer length screws the threaded

portion $l_2 < l_1$.

See technical page for tightening torques.

Order No.	d ₁	l ₁	d ₂	l ₂	h ₁	A/F
P0222.030-006-A2	M 3	6	6	-	1.7	2.0
P0222.030-008-A2	M 3	8	6	-	1.7	2.0
P0222.030-010-A2	M 3	10	6	-	1.7	2.0
P0222.030-012-A2	M 3	12	6	-	1.7	2.0
P0222.030-014-A2	M 3	14	6	12	1.7	2.0
P0222.030-016-A2	M 3	16	6	12	1.7	2.0
P0222.030-018-A2	M 3	18	6	12	1.7	2.0
P0222.030-020-A2	M 3	20	6	12	1.7	2.0
P0222.030-022-A2	M 3	22	6	12	1.7	2.0
P0222.030-025-A2	M 3	25	6	12	1.7	2.0
P0222.030-030-A2	M 3	30	6	12	1.7	2.0
P0222.030-035-A2	M 3	35	6	12	1.7	2.0
P0222.030-040-A2	M 3	40	6	12	1.7	2.0
P0222.040-006-A2	M 4	6	8	-	2.3	2.5
P0222.040-008-A2	M 4	8	8	-	2.3	2.5
P0222.040-010-A2	M 4	10	8	-	2.3	2.5
P0222.040-012-A2	M 4	12	8	-	2.3	2.5
P0222.040-014-A2	M 4	14	8	-	2.3	2.5
P0222.040-016-A2	M 4	16	8	14	2.3	2.5
P0222.040-018-A2	M 4	18	8	14	2.3	2.5
P0222.040-020-A2	M 4	20	8	14	2.3	2.5
P0222.040-022-A2	M 4	22	8	14	2.3	2.5
P0222.040-025-A2	M 4	25	8	14	2.3	2.5
P0222.040-030-A2	M 4	30	8	14	2.3	2.5
P0222.040-035-A2	M 4	35	8	14	2.3	2.5
P0222.040-040-A2	M 4	40	8	14	2.3	2.5
P0222.040-045-A2	M 4	45	8	14	2.3	2.5
P0222.040-050-A2	M 4	50	8	14	2.3	2.5
P0222.040-055-A2	M 4	55	8	14	2.3	2.5
P0222.040-060-A2	M 4	60	8	14	2.3	2.5
P0222.040-065-A2	M 4	65	8	14	2.3	2.5
P0222.040-070-A2	M 4	70	8	14	2.3	2.5
P0222.050-006-A2	M 5	6	10	-	2.8	3.0
P0222.050-008-A2	M 5	8	10	-	2.8	3.0



STANDARD SCREWS

Order No.	d ₁	l ₁	d ₂	l ₂	h ₁	A/F
P0222.050-010-A2	M 5	10	10	-	2.8	3.0
P0222.050-012-A2	M 5	12	10	-	2.8	3.0
P0222.050-014-A2	M 5	14	10	-	2.8	3.0
P0222.050-016-A2	M 5	16	10	-	2.8	3.0
P0222.050-018-A2	M 5	18	10	16	2.8	3.0
P0222.050-020-A2	M 5	20	10	16	2.8	3.0
P0222.050-022-A2	M 5	22	10	16	2.8	3.0
P0222.050-025-A2	M 5	25	10	16	2.8	3.0
P0222.050-030-A2	M 5	30	10	16	2.8	3.0
P0222.050-035-A2	M 5	35	10	16	2.8	3.0
P0222.050-040-A2	M 5	40	10	16	2.8	3.0
P0222.050-045-A2	M 5	45	10	16	2.8	3.0
P0222.050-050-A2	M 5	50	10	16	2.8	3.0
P0222.050-055-A2	M 5	55	10	16	2.8	3.0
P0222.050-060-A2	M 5	60	10	16	2.8	3.0
P0222.050-065-A2	M 5	65	10	16	2.8	3.0
P0222.050-070-A2	M 5	70	10	16	2.8	3.0
P0222.050-075-A2	M 5	75	10	16	2.8	3.0
P0222.050-080-A2	M 5	80	10	16	2.8	3.0
P0222.050-085-A2	M 5	85	10	16	2.8	3.0
P0222.050-090-A2	M 5	90	10	16	2.8	3.0
P0222.050-095-A2	M 5	95	10	16	2.8	3.0
P0222.050-100-A2	M 5	100	10	16	2.8	3.0
P0222.060-008-A2	M 6	8	12.0	-	3.30	4.0
P0222.060-010-A2	M 6	10	12.0	-	3.30	4.0
P0222.060-012-A2	M 6	12	12.0	-	3.30	4.0
P0222.060-014-A2	M 6	14	12.0	-	3.30	4.0
P0222.060-016-A2	M 6	16	12.0	-	3.30	4.0
P0222.060-018-A2	M 6	18	12.0	-	3.30	4.0
P0222.060-020-A2	M 6	20	12.0	18	3.30	4.0
P0222.060-022-A2	M 6	22	12.0	18	3.30	4.0
P0222.060-025-A2	M 6	25	12.0	18	3.30	4.0
P0222.060-030-A2	M 6	30	12.0	18	3.30	4.0
P0222.060-035-A2	M 6	35	12.0	18	3.30	4.0
P0222.060-040-A2	M 6	40	12.0	18	3.30	4.0
P0222.060-045-A2	M 6	45	12.0	18	3.30	4.0
P0222.060-050-A2	M 6	50	12.0	18	3.30	4.0
P0222.060-055-A2	M 6	55	12.0	18	3.30	4.0
P0222.060-060-A2	M 6	60	12.0	18	3.30	4.0
P0222.060-065-A2	M 6	65	12.0	18	3.30	4.0
P0222.060-070-A2	M 6	70	12.0	18	3.30	4.0
P0222.060-075-A2	M 6	75	12.0	18	3.30	4.0
P0222.060-080-A2	M 6	80	12.0	18	3.30	4.0
P0222.060-085-A2	M 6	85	12.0	18	3.30	4.0
P0222.060-090-A2	M 6	90	12.0	18	3.30	4.0
P0222.060-095-A2	M 6	95	12.0	18	3.30	4.0
P0222.060-100-A2	M 6	100	12.0	18	3.30	4.0
P0222.080-010-A2	M 8	10	16.0	-	4.40	5.0
P0222.080-012-A2	M 8	12	16.0	-	4.40	5.0
P0222.080-014-A2	M 8	14	16.0	-	4.40	5.0
P0222.080-016-A2	M 8	16	16.0	-	4.40	5.0
P0222.080-018-A2	M 8	18	16.0	-	4.40	5.0
P0222.080-020-A2	M 8	20	16.0	-	4.40	5.0
P0222.080-022-A2	M 8	22	16.0	-	4.40	5.0
P0222.080-025-A2	M 8	25	16.0	22	4.40	5.0
P0222.080-030-A2	M 8	30	16.0	22	4.40	5.0
P0222.080-035-A2	M 8	35	16.0	22	4.40	5.0
P0222.080-040-A2	M 8	40	16.0	22	4.40	5.0
P0222.080-045-A2	M 8	45	16.0	22	4.40	5.0
P0222.080-050-A2	M 8	50	16.0	22	4.40	5.0
P0222.080-055-A2	M 8	55	16.0	22	4.40	5.0
P0222.080-060-A2	M 8	60	16.0	22	4.40	5.0
P0222.080-065-A2	M 8	65	16.0	22	4.40	5.0
P0222.080-070-A2	M 8	70	16.0	22	4.40	5.0
P0222.080-075-A2	M 8	75	16.0	22	4.40	5.0
P0222.080-080-A2	M 8	80	16.0	22	4.40	5.0
P0222.080-085-A2	M 8	85	16.0	22	4.40	5.0
P0222.080-090-A2	M 8	90	16.0	22	4.40	5.0
P0222.080-095-A2	M 8	95	16.0	22	4.40	5.0



Socket Countersunk Machine Screws

Socket - A2 stainless

Standard Screws



Order No.	d ₁	l ₁	d ₂	l ₂	h ₁	A/F
P0222.080-100-A2	M 8	100	16.0	22	4.40	5.0
P0222.080-110-A2	M 8	110	16.0	22	4.40	5.0
P0222.080-120-A2	M 8	120	16.0	22	4.40	5.0
P0222.080-130-A2	M 8	130	16.0	22	4.40	5.0
P0222.080-140-A2	M 8	140	16.0	22	4.40	5.0
P0222.080-150-A2	M 8	150	16.0	22	4.40	5.0
P0222.080-160-A2	M 8	160	16.0	22	4.40	5.0
P0222.100-016-A2	M10	16	20.0	-	5.50	6.0
P0222.100-018-A2	M10	18	20.0	-	5.50	6.0
P0222.100-020-A2	M10	20	20.0	-	5.50	6.0
P0222.100-022-A2	M10	22	20.0	-	5.50	6.0
P0222.100-025-A2	M10	25	20.0	-	5.50	6.0
P0222.100-030-A2	M10	30	20.0	26	5.50	6.0
P0222.100-035-A2	M10	35	20.0	26	5.50	6.0
P0222.100-040-A2	M10	40	20.0	26	5.50	6.0
P0222.100-045-A2	M10	45	20.0	26	5.50	6.0
P0222.100-050-A2	M10	50	20.0	26	5.50	6.0
P0222.100-055-A2	M10	55	20.0	26	5.50	6.0
P0222.100-060-A2	M10	60	20.0	26	5.50	6.0
P0222.100-065-A2	M10	65	20.0	26	5.50	6.0
P0222.100-070-A2	M10	70	20.0	26	5.50	6.0
P0222.100-075-A2	M10	75	20.0	26	5.50	6.0
P0222.100-080-A2	M10	80	20.0	26	5.50	6.0
P0222.100-085-A2	M10	85	20.0	26	5.50	6.0
P0222.100-090-A2	M10	90	20.0	26	5.50	6.0
P0222.100-095-A2	M10	95	20.0	26	5.50	6.0
P0222.100-100-A2	M10	100	20.0	26	5.50	6.0
P0222.100-110-A2	M10	110	20.0	26	5.50	6.0
P0222.100-120-A2	M10	120	20.0	26	5.50	6.0
P0222.100-130-A2	M10	130	20.0	26	5.50	6.0
P0222.100-140-A2	M10	140	20.0	26	5.50	6.0
P0222.100-150-A2	M10	150	20.0	26	5.50	6.0
P0222.100-160-A2	M10	160	20.0	26	5.50	6.0
P0222.120-016-A2	M12	16	24.0	-	6.50	8.0
P0222.120-018-A2	M12	18	24.0	-	6.50	8.0
P0222.120-020-A2	M12	20	24.0	-	6.50	8.0
P0222.120-022-A2	M12	22	24.0	-	6.50	8.0
P0222.120-025-A2	M12	25	24.0	-	6.50	8.0
P0222.120-030-A2	M12	30	24.0	-	6.50	8.0
P0222.120-035-A2	M12	35	24.0	30	6.50	8.0
P0222.120-040-A2	M12	40	24.0	30	6.50	8.0
P0222.120-045-A2	M12	45	24.0	30	6.50	8.0
P0222.120-050-A2	M12	50	24.0	30	6.50	8.0
P0222.120-055-A2	M12	55	24.0	30	6.50	8.0
P0222.120-060-A2	M12	60	24.0	30	6.50	8.0
P0222.120-065-A2	M12	65	24.0	30	6.50	8.0
P0222.120-070-A2	M12	70	24.0	30	6.50	8.0
P0222.120-075-A2	M12	75	24.0	30	6.50	8.0
P0222.120-080-A2	M12	80	24.0	30	6.50	8.0
P0222.120-085-A2	M12	85	24.0	30	6.50	8.0
P0222.120-090-A2	M12	90	24.0	30	6.50	8.0
P0222.120-095-A2	M12	95	24.0	30	6.50	8.0
P0222.120-100-A2	M12	100	24.0	30	6.50	8.0
P0222.120-110-A2	M12	110	24.0	30	6.50	8.0
P0222.120-120-A2	M12	120	24.0	30	6.50	8.0
P0222.120-130-A2	M12	130	24.0	30	6.50	8.0
P0222.120-140-A2	M12	140	24.0	30	6.50	8.0
P0222.120-150-A2	M12	150	24.0	30	6.50	8.0
P0222.120-160-A2	M12	160	24.0	30	6.50	8.0
P0222.160-025-A2	M16	25	30.0	-	7.50	10.0
P0222.160-030-A2	M16	30	30.0	-	7.50	10.0
P0222.160-035-A2	M16	35	30.0	-	7.50	10.0
P0222.160-040-A2	M16	40	30.0	38	7.50	10.0
P0222.160-045-A2	M16	45	30.0	38	7.50	10.0
P0222.160-050-A2	M16	50	30.0	38	7.50	10.0
P0222.160-055-A2	M16	55	30.0	38	7.50	10.0
P0222.160-060-A2	M16	60	30.0	38	7.50	10.0
P0222.160-065-A2	M16	65	30.0	38	7.50	10.0
P0222.160-070-A2	M16	70	30.0	38	7.50	10.0

STANDARD SCREWS



STANDARD SCREWS

Order No.	d ₁	l ₁	d ₂	l ₂	h ₁	A/F
P0222.160-075-A2	M16	75	30.0	38	7.50	10.0
P0222.160-080-A2	M16	80	30.0	38	7.50	10.0
P0222.160-085-A2	M16	85	30.0	38	7.50	10.0
P0222.160-090-A2	M16	90	30.0	38	7.50	10.0
P0222.160-095-A2	M16	95	30.0	38	7.50	10.0
P0222.160-100-A2	M16	100	30.0	38	7.50	10.0
P0222.160-110-A2	M16	110	30.0	38	7.50	10.0
P0222.160-120-A2	M16	120	30.0	38	7.50	10.0
P0222.160-130-A2	M16	130	30.0	38	7.50	10.0
P0222.160-140-A2	M16	140	30.0	38	7.50	10.0
P0222.160-150-A2	M16	150	30.0	38	7.50	10.0
P0222.160-160-A2	M16	160	30.0	38	7.50	10.0
P0222.200-035-A2	M20	35	36.0	-	8.50	12.0
P0222.200-040-A2	M20	40	36.0	-	8.50	12.0
P0222.200-045-A2	M20	45	36.0	-	8.50	12.0
P0222.200-050-A2	M20	50	36.0	46	8.50	12.0
P0222.200-055-A2	M20	55	36.0	46	8.50	12.0
P0222.200-060-A2	M20	60	36.0	46	8.50	12.0
P0222.200-065-A2	M20	65	36.0	46	8.50	12.0
P0222.200-070-A2	M20	70	36.0	46	8.50	12.0
P0222.200-075-A2	M20	75	36.0	46	8.50	12.0
P0222.200-080-A2	M20	80	36.0	46	8.50	12.0
P0222.200-085-A2	M20	85	36.0	46	8.50	12.0
P0222.200-090-A2	M20	90	36.0	46	8.50	12.0
P0222.200-095-A2	M20	95	36.0	46	8.50	12.0
P0222.200-100-A2	M20	100	36.0	46	8.50	12.0
P0222.200-110-A2	M20	110	36.0	46	8.50	12.0
P0222.200-120-A2	M20	120	36.0	46	8.50	12.0
P0222.200-130-A2	M20	130	36.0	46	8.50	12.0
P0222.200-140-A2	M20	140	36.0	46	8.50	12.0
P0222.200-150-A2	M20	150	36.0	46	8.50	12.0
P0222.200-160-A2	M20	160	36.0	46	8.50	12.0
P0222.240-050-A2	M24	50	39.0	-	14.0	14.0
P0222.240-055-A2	M24	55	39.0	-	14.0	14.0
P0222.240-060-A2	M24	60	39.0	54	14.0	14.0
P0222.240-065-A2	M24	65	39.0	54	14.0	14.0
P0222.240-070-A2	M24	70	39.0	54	14.0	14.0
P0222.240-075-A2	M24	75	39.0	54	14.0	14.0
P0222.240-080-A2	M24	80	39.0	54	14.0	14.0
P0222.240-085-A2	M24	85	39.0	54	14.0	14.0
P0222.240-090-A2	M24	90	39.0	54	14.0	14.0
P0222.240-095-A2	M24	95	39.0	54	14.0	14.0
P0222.240-100-A2	M24	100	39.0	54	14.0	14.0
P0222.240-110-A2	M24	110	39.0	54	14.0	14.0
P0222.240-120-A2	M24	120	39.0	54	14.0	14.0
P0222.240-130-A2	M24	130	39.0	54	14.0	14.0
P0222.240-140-A2	M24	140	39.0	54	14.0	14.0
P0222.240-150-A2	M24	150	39.0	54	14.0	14.0
P0222.240-160-A2	M24	160	39.0	54	14.0	14.0