

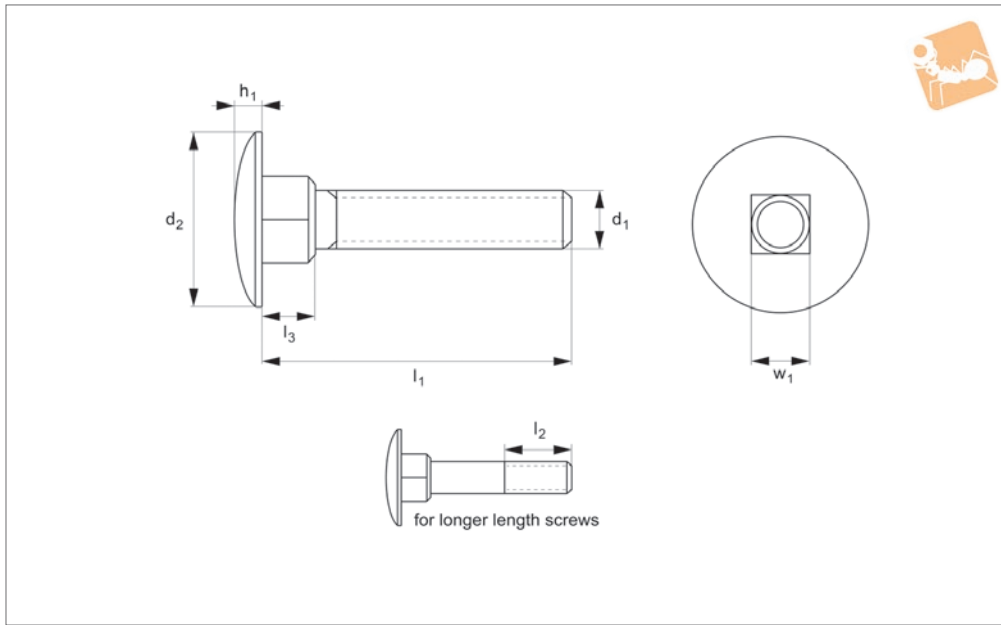

Carriage Bolts - Partial Thread

Part thread - A4 stainless

Standard Screws



P0265.A4

STANDARD SCREWS

Material

Stainless steel (A4).

See technical page for tightening torques.

Technical Notes

To DIN 603.

Order No.	d ₁	l ₁	h ₁	d ₂	l ₂	w ₁
P0265.050-016-A4	M5	16	2.7	12.45	16	4.52
P0265.050-020-A4	M5	20	2.7	12.45	16	4.52
P0265.050-025-A4	M5	25	2.7	12.45	16	4.52
P0265.050-030-A4	M5	30	2.7	12.45	16	4.52
P0265.050-035-A4	M5	35	2.7	12.45	16	4.52
P0265.050-040-A4	M5	40	2.7	12.45	16	4.52
P0265.050-045-A4	M5	45	2.7	12.45	16	4.52
P0265.050-050-A4	M5	50	2.7	12.45	16	4.52
P0265.050-055-A4	M5	55	2.7	12.45	16	4.52
P0265.050-060-A4	M5	60	2.7	12.45	16	4.52
P0265.050-065-A4	M5	65	2.7	12.45	16	4.52
P0265.050-070-A4	M5	70	2.7	12.45	16	4.52
P0265.050-075-A4	M5	75	2.7	12.45	16	4.52
P0265.050-080-A4	M5	80	2.7	12.45	16	4.52
P0265.060-012-A4	M6	12	3.12	15.45	18	5.52
P0265.060-016-A4	M6	16	3.12	15.45	18	5.52
P0265.060-020-A4	M6	20	3.12	15.45	18	5.52
P0265.060-025-A4	M6	25	3.12	15.45	18	5.52
P0265.060-030-A4	M6	30	3.12	15.45	18	5.52
P0265.060-035-A4	M6	35	3.12	15.45	18	5.52
P0265.060-040-A4	M6	40	3.12	15.45	18	5.52
P0265.060-045-A4	M6	45	3.12	15.45	18	5.52
P0265.060-050-A4	M6	50	3.12	15.45	18	5.52
P0265.060-055-A4	M6	55	3.12	15.45	18	5.52
P0265.060-060-A4	M6	60	3.12	15.45	18	5.52
P0265.060-065-A4	M6	65	3.12	15.45	18	5.52
P0265.060-070-A4	M6	70	3.12	15.45	18	5.52
P0265.060-075-A4	M6	75	3.12	15.45	18	5.52
P0265.060-080-A4	M6	80	3.12	15.45	18	5.52
P0265.060-090-A4	M6	90	3.12	15.45	18	5.52
P0265.060-100-A4	M6	100	3.12	15.45	18	5.52
P0265.060-110-A4	M6	110	3.12	15.45	18	5.52
P0265.060-120-A4	M6	120	3.12	15.45	18	5.52
P0265.060-130-A4	M6	130	3.12	15.45	24	5.52



STANDARD SCREWS

Order No.	d ₁	l ₁	h ₁	d ₂	l ₂	w ₁
P0265.060-140-A4	M6	140	3.12	15.45	24	5.52
P0265.080-016-A4	M8	16	4.12	19.35	22	7.42
P0265.080-020-A4	M8	20	4.12	19.35	22	7.42
P0265.080-025-A4	M8	25	4.12	19.35	22	7.42
P0265.080-030-A4	M8	30	4.12	19.35	22	7.42
P0265.080-035-A4	M8	35	4.12	19.35	22	7.42
P0265.080-040-A4	M8	40	4.12	19.35	22	7.42
P0265.080-045-A4	M8	45	4.12	19.35	22	7.42
P0265.080-050-A4	M8	50	4.12	19.35	22	7.42
P0265.080-055-A4	M8	55	4.12	19.35	22	7.42
P0265.080-060-A4	M8	60	4.12	19.35	22	7.42
P0265.080-065-A4	M8	65	4.12	19.35	22	7.42
P0265.080-070-A4	M8	70	4.12	19.35	22	7.42
P0265.080-075-A4	M8	75	4.12	19.35	22	7.42
P0265.080-080-A4	M8	80	4.12	19.35	22	7.42
P0265.080-090-A4	M8	90	4.12	19.35	22	7.42
P0265.080-100-A4	M8	100	4.12	19.35	22	7.42
P0265.080-110-A4	M8	110	4.12	19.35	22	7.42
P0265.080-120-A4	M8	120	4.12	19.35	22	7.42
P0265.080-130-A4	M8	130	4.12	19.35	28	7.42
P0265.080-140-A4	M8	140	4.12	19.35	28	7.42
P0265.080-150-A4	M8	150	4.12	19.35	28	7.42
P0265.080-160-A4	M8	160	4.12	19.35	28	7.42
P0265.080-170-A4	M8	170	4.12	19.35	28	7.42
P0265.080-180-A4	M8	180	4.12	19.35	28	7.42
P0265.080-200-A4	M8	200	4.12	19.35	28	7.42
P0265.100-016-A4	M10	16	4.62	23.25	26	9.42
P0265.100-020-A4	M10	20	4.62	23.25	26	9.42
P0265.100-025-A4	M10	25	4.62	23.25	26	9.42
P0265.100-030-A4	M10	30	4.62	23.25	26	9.42
P0265.100-035-A4	M10	35	4.62	23.25	26	9.42
P0265.100-040-A4	M10	40	4.62	23.25	26	9.42
P0265.100-045-A4	M10	45	4.62	23.25	26	9.42
P0265.100-050-A4	M10	50	4.62	23.25	26	9.42
P0265.100-055-A4	M10	55	4.62	23.25	26	9.42
P0265.100-060-A4	M10	60	4.62	23.25	26	9.42
P0265.100-065-A4	M10	65	4.62	23.25	26	9.42
P0265.100-070-A4	M10	70	4.62	23.25	26	9.42
P0265.100-075-A4	M10	75	4.62	23.25	26	9.42
P0265.100-080-A4	M10	80	4.62	23.25	26	9.42
P0265.100-090-A4	M10	90	4.62	23.25	26	9.42
P0265.100-100-A4	M10	100	4.62	23.25	26	9.42
P0265.100-110-A4	M10	110	4.62	23.25	26	9.42
P0265.100-120-A4	M10	120	4.62	23.25	26	9.42
P0265.100-130-A4	M10	130	4.62	23.25	32	9.42
P0265.100-140-A4	M10	140	4.62	23.25	32	9.42
P0265.100-150-A4	M10	150	4.62	23.25	32	9.42
P0265.100-160-A4	M10	160	4.62	23.25	32	9.42
P0265.100-170-A4	M10	170	4.62	23.25	32	9.42
P0265.100-180-A4	M10	180	4.62	23.25	32	9.42
P0265.100-200-A4	M10	200	4.62	23.25	32	9.42
P0265.120-025-A4	M12	25	6.05	29.25	30	11.3
P0265.120-030-A4	M12	30	6.05	29.25	30	11.3
P0265.120-035-A4	M12	35	6.05	29.25	30	11.3
P0265.120-040-A4	M12	40	6.05	29.25	30	11.3
P0265.120-045-A4	M12	45	6.05	29.25	30	11.3
P0265.120-050-A4	M12	50	6.05	29.25	30	11.3
P0265.120-055-A4	M12	55	6.05	29.25	30	11.3
P0265.120-060-A4	M12	60	6.05	29.25	30	11.3
P0265.120-065-A4	M12	65	6.05	29.25	30	11.3
P0265.120-070-A4	M12	70	6.05	29.25	30	11.3
P0265.120-075-A4	M12	75	6.05	29.25	30	11.3
P0265.120-080-A4	M12	80	6.05	29.25	30	11.3
P0265.120-090-A4	M12	90	6.05	29.25	30	11.3
P0265.120-100-A4	M12	100	6.05	29.25	30	11.3
P0265.120-110-A4	M12	110	6.05	29.25	30	11.3
P0265.120-120-A4	M12	120	6.05	29.25	30	11.3
P0265.120-130-A4	M12	130	6.05	29.25	36	11.3
P0265.120-140-A4	M12	140	6.05	29.25	36	11.3



Carriage Bolts - Partial Thread

Part thread - A4 stainless

Standard Screws

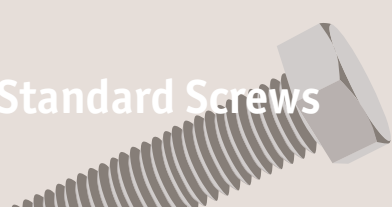

Order No.	d ₁	l ₁	h ₁	d ₂	l ₂	w ₁
P0265.120-150-A4	M12	150	6.05	29.25	36	11.3
P0265.120-160-A4	M12	160	6.05	29.25	36	11.3
P0265.120-170-A4	M12	170	6.05	29.25	36	11.3
P0265.120-180-A4	M12	180	6.05	29.25	36	11.3
P0265.120-200-A4	M12	200	6.05	29.25	36	11.3
P0265.160-040-A4	M16	40	8.05	37.20	38	15.3
P0265.160-045-A4	M16	45	8.05	37.20	38	15.3
P0265.160-050-A4	M16	50	8.05	37.20	38	15.3
P0265.160-055-A4	M16	55	8.05	37.20	38	15.3
P0265.160-060-A4	M16	60	8.05	37.20	38	15.3
P0265.160-065-A4	M16	65	8.05	37.20	38	15.3
P0265.160-070-A4	M16	70	8.05	37.20	38	15.3
P0265.160-075-A4	M16	75	8.05	37.20	38	15.3
P0265.160-080-A4	M16	80	8.05	37.20	38	15.3
P0265.160-090-A4	M16	90	8.05	37.20	38	15.3
P0265.160-100-A4	M16	100	8.05	37.20	38	15.3
P0265.160-110-A4	M16	110	8.05	37.20	38	15.3
P0265.160-120-A4	M16	120	8.05	37.20	38	15.3
P0265.160-130-A4	M16	130	8.05	37.20	44	15.3
P0265.160-140-A4	M16	140	8.05	37.20	44	15.3
P0265.160-150-A4	M16	150	8.05	37.20	44	15.3
P0265.160-160-A4	M16	160	8.05	37.20	44	15.3
P0265.160-170-A4	M16	170	8.05	37.20	44	15.3
P0265.160-180-A4	M16	180	8.05	37.20	44	15.3
P0265.160-200-A4	M16	200	8.05	37.20	44	15.3

STANDARD SCREWS