

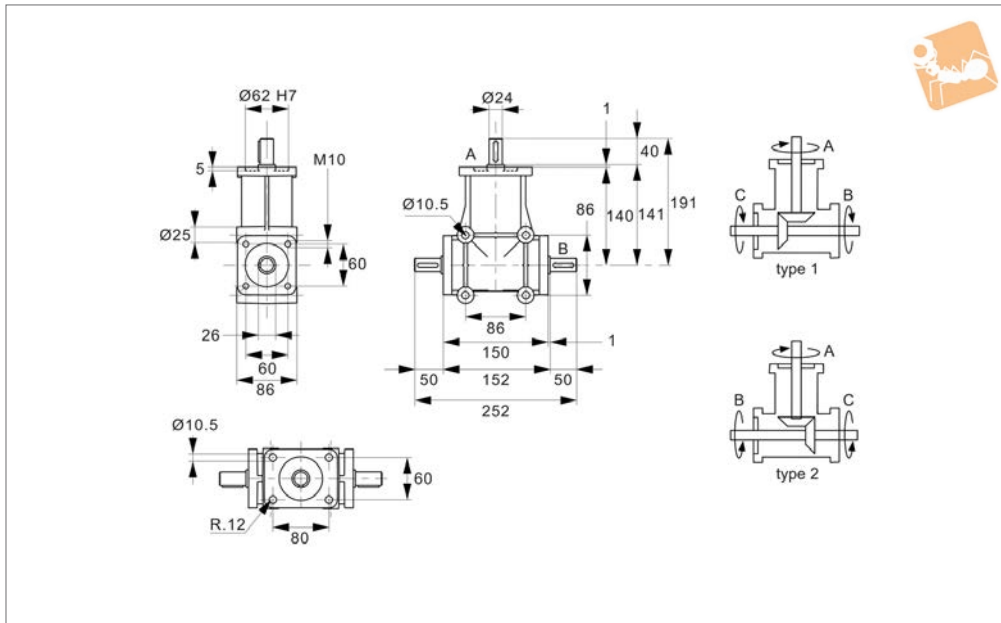

Right Angle Drives - 3 Shafts

Ø24 shafts

Right Angle Gear Boxes



R2334

RIGHT ANGLE GEAR BOXES

Material

Lightweight aluminium alloy housing.
Case-hardened steel gears and shafts.

Technical Notes

Normally used as speed reducers.
Shaft A is the input shaft. Optimum performance based on max. 1400 rpm input.
Provides on average 10,000 hours trouble-

free life.

Where ratio geared units are used as speed increasers the optimum input speed is 750 rpm for 1:2 ratios.

Very low operating noise levels. Temperature range is -20° to +80°.
Max. radial loading :80 Kg.
Max. axial loading: 16 Kg.

Angular alignment: 15' to 30' of arc.

Tips

See technical pages for gear box selection guide, based on motor rating, gearing ratio, load type and expected hourly usage hours.

Order No.	Shaft dia. tol. f7	Ratio	Input shaft A kW max.	Output shaft B Nm max.	Output shaft C Nm max.	Weight kg
R2334.1	24	1:1	6.7	25.0	25.0	4.40
R2334.2	24	2:1	4.1	14.0	14.0	4.40
R2334.3	24	3:1	2.2	10.5	10.5	4.40