

R3685

UNIVERSAL JOINTS

Material

Steel (9SMnPb28k, no. 10718).
Bearing type: Plain bearing.

Technical Notes

To DIN 808, keyways aligned.
Maximum bending angle 45° per joint.

Max. drive speed of 1000 rpm.

Tips

Double universal joints are used where large bending angles are required or where two shafts offset in relation to each other.
Product variations available on request, for

square bores change the suffix to SQ for square bores or HX for hex bores.

For stainless steel see part number R3696, for needle roller bearings see part number R3686.

Order No.	Bore dia.	d ₁ tol. H7	d ₂	l ₁	l ₂	l ₃	l ₄	w ₁ tol. JS9	w ₂	Weight g
R3685.006-RB	Round Bore	6	16	56	17.0	22	8	-	-	80
R3685.008-RB	Round Bore	8	16	62	20.0	22	11	-	-	80
R3685.010-RB	Round Bore	10	22	74	24.0	26	12	-	-	150
R3685.012-RB	Round Bore	12	25	86	28.0	30	13	-	-	250
R3685.014-RB	Round Bore	14	28	96	30.0	36	14	-	-	400
R3685.016-RB	Round Bore	16	32	104	34.0	36	16	-	-	450
R3685.018-RB	Round Bore	18	36	114	37.0	40	17	-	-	700
R3685.020-RB	Round Bore	20	42	128	41.0	46	18	-	-	1000
R3685.022-RB	Round Bore	22	45	145	47.5	50	22	-	-	1550
R3685.025-RB	Round Bore	25	50	163	54.0	55	26	-	-	2000
R3685.030-RB	Round Bore	30	58	190	61.0	68	29	-	-	2900
R3685.032-RB	Round Bore	32	58	198	65.0	68	33	-	-	3000
R3685.035-RB	Round Bore	35	70	212	70.0	72	35	-	-	4750
R3685.040-RB	Round Bore	40	80	245	80.0	85	39	-	-	7200
R3685.050-RB	Round Bore	50	95	290	95.0	100	46	-	-	12.000
R3685.006-KW	With Keyway	6	16	56	17.0	22	8	2	7	80
R3685.008-KW	With Keyway	8	16	62	20.0	22	11	2	9	80
R3685.010-KW	With Keyway	10	22	74	24.0	26	12	3	11.4	150
R3685.012-KW	With Keyway	12	25	86	28.0	30	13	4	13.8	250
R3685.014-KW	With Keyway	14	28	96	30.0	36	14	5	16.3	400
R3685.016-KW	With Keyway	16	32	104	34.0	36	16	5	18.3	450
R3685.018-KW	With Keyway	18	36	114	37.0	40	17	6	20.8	700
R3685.020-KW	With Keyway	20	42	128	41.0	46	18	6	22.8	1000
R3685.022-KW	With Keyway	22	45	145	47.5	50	22	6	24.8	1550
R3685.025-KW	With Keyway	25	50	163	54.0	55	26	8	28.3	2000
R3685.030-KW	With Keyway	30	58	190	61.0	68	29	8	33.3	2900
R3685.032-KW	With Keyway	32	58	198	65.0	68	33	10	35.3	3000
R3685.035-KW	With Keyway	35	70	212	70.0	72	35	10	38.3	4750
R3685.040-KW	With Keyway	40	80	245	80.0	85	39	12	43.3	7200
R3685.050-KW	With Keyway	50	95	290	95.0	100	46	14	53.8	12.000



Parts overview

UNIVERSAL JOINTS

Single Universal Joints

Available with plain bearings or needle roller bearings. Plain bore and keyed bores stocked as standard, hex or square shaped bores on request. Bore diameters 6mm up to 50mm.



Double Universal Joints

Available with plain bearings or needle roller bearings. Plain bore and keyed bores stocked as standard, hex or square shaped bores on request. Bore diameters 6mm up to 50mm.



Stainless Steel Universal Joints

Single and double universal joints with plain bearings and plain bores. Keyed, hex or square shaped bores available on request. Bore diameters 6mm up to 30mm.



Quick Release Universal Joints

Quick change mechanism one end of the joint to allow rapid connection and release of the shaft, ideal when time is critical. Bore diameters 8mm up to 30mm.



Universal Joint Bellows

Available for both single and double universal joints, bellows are used to cover and protect the joints. Available to protect joints up to 58mm outside diameter.



Telescopic Universal Joints

Two universal joints connected by a sliding splined shaft with the ability to extend, allowing adjustments in length during installation. Bore diameters 10mm up to 30mm.



When one single joint is coupled with two shafts (of which the driving one is rotating at a constant speed) forming an angle, a periodic variation of the driven shaft is caused with exactly four fluctuations per revolution.

The difference between the maximum and the minimum speed of the driven shaft depends on the angle formed by the two shafts. The difference grows with the an increase of the angle a° . To have a homokinetic transmission, either two opposite single joints (ensuing that that the two central yokes lie on the same plane and the angles are equal) or a double joint need to be fitted. The irregularity caused by the former articulation is cancelled by the latter. The overall length resulting from the coupling of the two single joints can be reduced by using a double joint. In other words, the double joint is to be considered as the shortest homokinetic transmission.

For low speed applications (Max. 1000 rpm), joints with plain bearings (rubbing bearings) are suggested. They are able to support shock loads, motion reversals, irregular runnings and relatively high torques. The working angles must be restricted when using at speeds between 500 - 1000 rpm. Please consult our technical department if you have such an application.

For high rotation speeds, relatively low torques or wide angles, joints with needle roller bearings are preferred. They can reach 4000 RPM dependent on the angle.

Dynamic basic load ratings of plain bearing rod ends

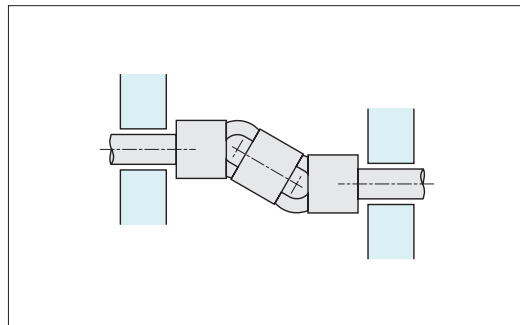
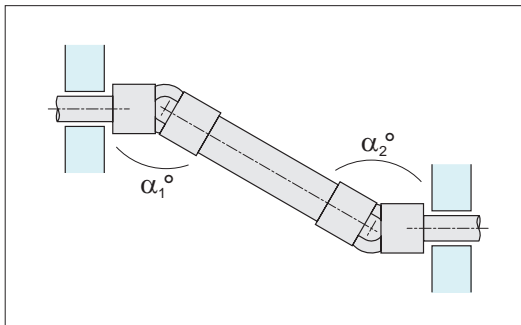

To obtain a uniform rotary motion always use either two opposite single joints or one double joints.
 $\alpha_1 = \alpha_2$.

The pillow block supports should be positioned as close as possible to the joints.

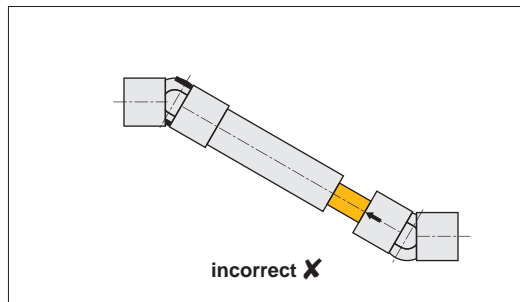
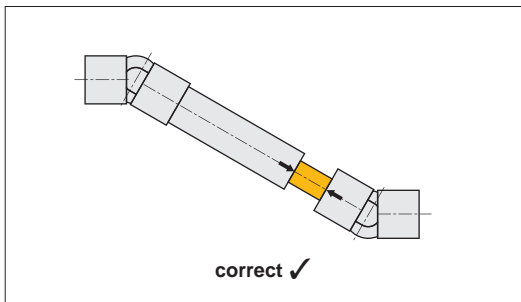

When using two opposite single joints ensure the alignment of the inside yokes.

In extensible transmissions make sure that the arrows are perfectly aligned.

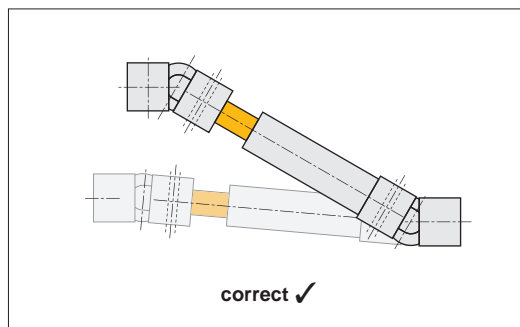
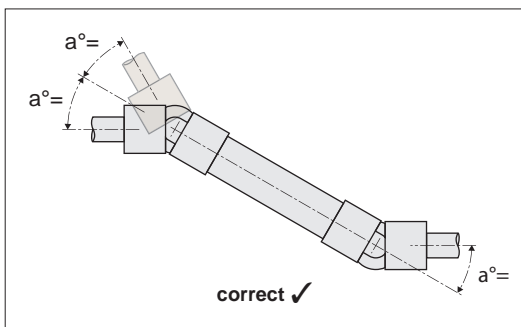

It is essential that the two bending angles a° are equal.



How to read diagrams

The joint capacity to transmit a regular torque at a constant load with no shocks, for a long period, mainly depends on the number of revolutions per minute and the inclination angle a° of the two axes. The diagrams on the following pages are based on this. Each curve corresponds to the joint size (outside diameter "D") and represents the torque that the joint can transmit depending on speed and working angle a° .

The diagrams can be directly read if angle (a°) is 10° . For wider angles, torques are reduced, therefore these are to be corrected using the correction vales (F) relating to the angle shown in the table.

Important Note: Diagrams' values are merely indicative and refer to the single joints only. When choosing a double joint, you have to consider that they can transmit a torque about 10% lower than the same sized single joints. Each application has its own particular motion characteristics, such as: shock loads, motion reversals, connected masses, kind of starting, presence of elastic joints, stops and starts, etc., that have to be considered when choosing the joint.

Working angle a°	Correction value F
5°	1,25
10°	1,00
15°	0,80
20°	0,65
25°	0,55
30°	0,45
35°	0,38
40°	0,30
45°	0,25

Example

Known: Power = 0,65 kW
RPM = 230

With working angle $a 10^\circ$, $F = 1$, we get point **P**. Torque = 27 Nm corresponding to joint size "D" = 25/26mm = Types **65170.W0016** and **65172.W0012**

With working angle $a 30^\circ$, $F = 0,45$ (kW 0,65: 0,45 = 1,44 kW) we get point **P1** Torque = 60 Nm corresponding to joint size "D" = 32mm = Types **65170.W0020** and **65172.W0016**

Consider that:

$$\text{Torque in Nm} = 9550 \times \frac{\text{Power (kW)}}{\text{RPM}}$$

$$\text{Torque in Nm} = 7020 \times \frac{\text{Power (HP)}}{\text{RPM}}$$

- 1 kW = 1,35 HP
- 1 HP = 0,736 kW
- 1 Kgm = 9,81 Nm
- 1 Nm = 0,102 Kgm



Torque Ratings for Plain Bearing Universal Joints

Materials Handling

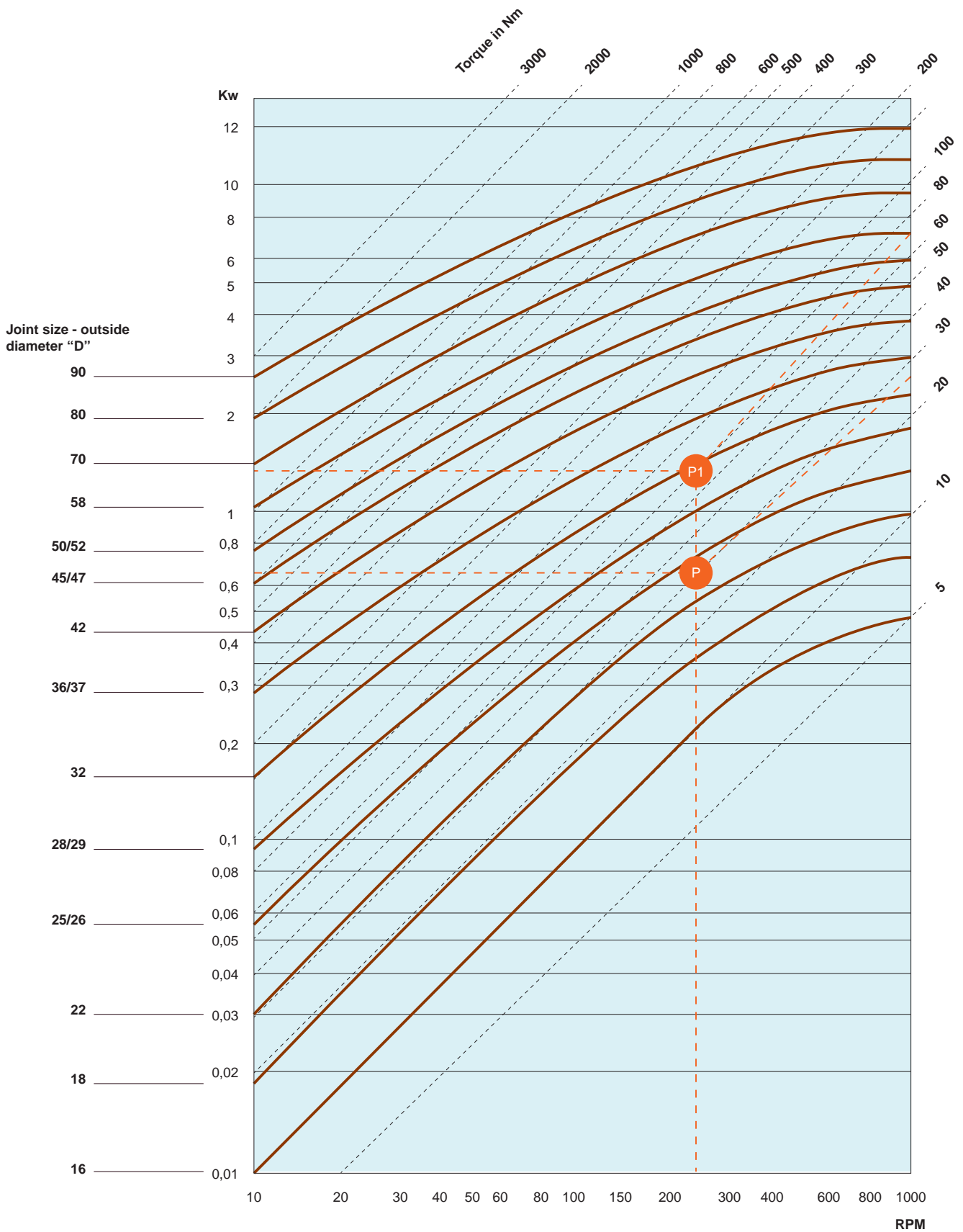

UNIVERSAL JOINTS

ov-W65142-AR3680-T-W65282-A-T-d-rmh-Updated -31-10-2022